

HIAB K-HiPro 505 X4

Operator's Manual GB

This operator's manual is an Original Instruction and applies to cranes with serial numbers from:
5050001.

2021-07

Congratulations with your new crane!

You are now the owner of a quality product from Cargotec, built to the highest standards of safety and quality.

The aim of this manual is to help you handle your crane safely and with full satisfaction.

Please read the complete manual. It provides detailed information about the crane, control system and the practical management and maintenance of the crane.

We advise you to read it carefully and familiarize yourself with your crane before you start to use it.

 Help us to improve this manual. Please send your comments and suggestions to documentation@hiab.com

 This manual includes interactive contents.

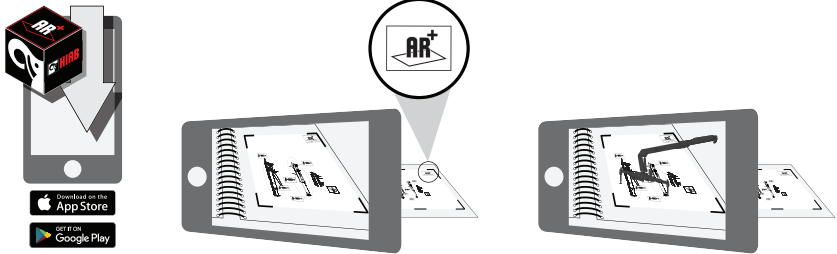

Download the **'Hiab AR+ App'** for the interactive content in this manual. Look for the **AR+** symbol. Use your device to scan the image next to the symbol.

The interactive contents in the Hiab AR+ App will display suggestions to make the crane operation easier for you to understand. However, note that some of the content included in the 'Hiab AR+ App' may differ from the actual configuration of your crane and is subject to updates and changes from Hiab without prior notice.

Table of Contents

1. Introduction	7
1.1. This Operator's Manual is intended for operators of this crane.	7
1.2. Cleanliness certificate	8
1.3. Indications in the Operator's Manual	8
2. Structure and parts of the crane	11
2.1. Main groups	11
2.2. Crane base with column and slewing system	11
2.3. Stabiliser system	11
2.4. Boom system	12
2.5. Accessories on the boom system	12
2.6. Operating system - hydraulic components	14
2.7. LHV Load holding valves	15
2.8. Description of HIAB K-HiPro 505	15
3. Safety precautions and warnings	16
3.1. Operating conditions	16
3.2. Wind speeds	17
3.3. Definition of this loader crane	17
3.3.1. Noise declaration	19
3.3.2. Signs on the crane	19
3.3.3. Maximum load [AR+]	19
3.3.4. 2nd Boom dual capacity	21
3.3.5. Maximum load moment	22
3.4. Signals when using a crane [AR+]	24
3.5. Use of the crane	27
3.5.1. Preparations for use	29
3.5.2. Crane operation	30
3.5.3. Driving with the crane	35
3.5.4. Use of lifting equipment	36
3.5.5. Use of demountable cranes	37
3.5.6. Ending crane operation	37
4. The HiPro system	38
4.1. Control System SPACE X4	38
4.2. How the safety system works	38
4.3. Components of the HiPro system	39
4.4. Standard symbols and functions of the crane and the stabiliser system	40
4.5. Main control valve	41
4.6. Different stabiliser control valves	42
4.7. User panel	42
4.7.1. Indicator LEDs on User Interface	42
4.8. Dump valves	44
4.9. Pressure-reducer filter	45
4.10. Warning lamps	45
4.11. XSDrive controller	45
4.11.1. Indicator LEDs on XSDrive controller	47
4.11.2. Buttons	48
4.11.3. Menus	49
4.11.4. Standard functions and symbols	50

4.11.5. Battery and battery charger XSDrive	51
4.12. CombiDrive controller	51
4.12.1. Displays	52
4.12.2. Buttons	54
4.12.3. Menus, standard functions and symbols	55
4.12.4. Battery and battery charger	59
5. Starting crane operation	61
5.1. Starting operations [AR+]	61
5.2. Set the stabiliser system	64
5.2.1. Stabiliser system and ground conditions	65
5.2.2. Activate the stabiliser system	66
5.2.3. Extend the stabiliser extensions	66
5.2.4. Set the stabiliser legs [AR+]	67
5.3. Operate the boom system out of transport position	69
6. During operation	71
6.1. Features	71
6.1.1. Controlling the crane speed with the controller XSDrive	71
6.1.2. Controlling the crane speed with the controller CombiDrive	71
6.1.3. Supervision of spools	72
6.1.4. APO Automatic power off	72
6.1.5. ADO Automatic Dumping of Oil	72
6.1.6. ASC Automatic Speed Control	72
6.1.7. ADC Automatic Duty Control	73
6.1.8. PFD Pump flow distribution	73
6.1.9. Slewing sector [option]	73
6.1.10. VSL Variable Stability Logic [option]	74
6.1.11. VSL+ (Variable Stability Logic Plus) [option]	76
6.1.12. LSS-V Load stabilising system-vertical [Option]	78
6.2. OLP (Overload protection)	78
6.3. OLP - indications on the controller	80
6.4. To release OLP	81
7. Ending crane operation	83
7.1. Operate the boom system into transport position	83
7.1.1. Operate the boom system	83
7.2. Placing the stabiliser system in the transport position [AR+]	84
7.3. Switching off the control system	87
7.4. Emergency operation Valve-V200	87
7.5. Transport warning [option]	89
8. Maintenance and Service	91
8.1. Service	91
8.2. Warranty	92
8.3. Follow the maintenance instructions!	92
8.3.1. Daily inspection	95
8.3.2. Monthly inspection and maintenance	99
8.3.3. Annual maintenance	100
8.4. Lubrication	100
8.4.1. Lubrication schedule	102
8.4.2. Greasing the upper column bearing and three-point bridge	103
8.4.3. Lubrication of slide pads in boom system	103
8.4.4. Lubrication of the hooks	104

8.5. Checking and topping up oil levels	104
8.5.1. Slewing housing: checking the oil level and topping up	104
8.5.2. Checking of the oil level of the tank	105
8.6. Replacement of filters	107
8.7. Bleeding air from the hydraulic system	108
8.8. Troubleshooting	109
8.8.1. Main fuses	109
8.8.2. Faults on the crane	110
8.8.3. Display [option]	113
8.8.4. Error codes	115
8.8.5. Gateway connection box [option]	116
9. Decommissioning	119
9.1. Decommissioning a crane	119
10. Technical Data	121
10.1. Load plate table	121
10.2. Identification of the loader crane	122
10.3. Abbreviations	122
10.4. Daily inspection checklist	123
10.5. Monthly inspection checklist	124

This page is intentionally left blank.

1. Introduction

1.1. This Operator's Manual is intended for operators of this crane.

This manual describes:

- Operation
- Safety precautions and warnings
- The crane control system
- Maintenance and troubleshooting

Enclosed to this manual the Installer will provide:

- Technical Data for your crane
- Technical Data and manuals for add on equipment if fitted

Study these instructions carefully



DANGER

If you do not study the complete Operator's Manual for your crane carefully, it could lead to fatal accidents or serious damage.

Therefore you should:

- Study the entire Operator's Manual carefully.
- Study the operating manuals for other add-on equipment, if fitted.
- Use the crane only after having done so.
- Follow the directions for use, operation and maintenance of the crane and add on equipment exactly.
- Store the Technical Data and manuals from the Installer, together with this Operator's manual.

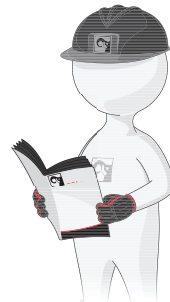

NOTE

The manufacturer reserves the right to change specifications, equipment, operating instructions and maintenance instructions without prior notice.

**NOTE**

Hiab shall at all times have the right to:

- install, maintain and dismantle remote diagnostics tools or similar sensor-based connectivity capabilities (“Connectivity”) in and from the Equipment; and
- access, send, receive, collect, store and use any and all information and data gathered through the Connectivity, including but not limited to, information concerning efficiency, availability, downtime, operation, operating environment, movement, condition, logon, location and similar information relating to the Equipment (the “Information”). Such Information may be used for optimizing the Equipment, or any related equipment or services as well as for Hiab’s internal business and/or operating purposes. Hiab shall be responsible for complying with applicable laws and regulations related to such Information.

The customer/user shall not in any way remove, disable, or interfere with the Connectivity or the Information. Any intellectual property rights or other right and title in and to the Connectivity features and the Information and all their further developments shall at all times be and remain the exclusive property of Hiab.

1.2. Cleanliness certificate

All Hiab equipment has been tested and certified at the factory according to the Hiab Standard C250.52 that defines the Cleanliness Requirements for Hydraulic Systems. This means that they fulfil the cleanliness class **20/18/14** measured by the ISO 4406 standard.

All hydraulic functions have been individually tested and fully comply with the defined requirements.



1.3. Indications in the Operator’s Manual

What must you do and not do?

The following indications are used in the Operator’s Manual:

**DANGER**

Danger to life for yourself or to bystanders.

Follow the instructions carefully!

**WARNING**

Danger of injury to yourself or to bystanders, or danger of serious damage to the crane or other objects.

Follow the instructions carefully.

**CAUTION**

Hazard for the crane or crane components. Follow the instructions carefully.

Important:

If actions are numbered

1. Do this
2. Do that
3.
4.
5.

you should carry them out in numerical order!

**NOTE**

Extra information that can prevent problems.

**TIP**

Tip to make the work easier to carry out.

The symbol for reference to a component in an illustration.

(1) Refers to a component in an illustration.

[option]: Indication for parts that are not standard for the crane, but are optional. Not all options are available for your crane.

Illustrations used in this manual are for guidance only, and the illustrations are provided to help identify the general area of a crane/installation referenced in the text.

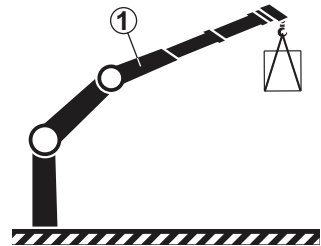
**DANGER**

Only persons with the requisite knowledge and experience with cranes may use the crane. Never operate the crane when you are sick, tired, under the influence of medicines, alcohol, or other drugs.

- Take the delivery instructions from your Hiab authorised service workshop, or receive instruction from an experienced person from your own company before you start to operate your crane.
- Make sure that you comply with the regulations of the country in which you use the crane (for example, certificate, safety helmet, and other personal protection devices).



DANGER

- Carry out yourself only the service and maintenance work you have the requisite knowledge and experience of.
- All other maintenance work may only be carried out by a Hiab authorised service workshop.
- Make sure that every defect is rectified immediately, according to the instructions.
- Follow the instructions exactly!
- All other work to rectify faults must be performed by personnel in a Hiab authorised service workshop!

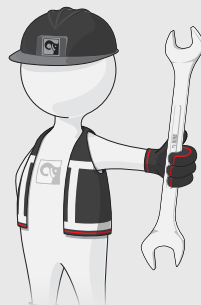

WARNING

- Never clean the electronic system, plastic components, signs, or bearings with a high-pressure jet cleaner. It could cause damage.
- Never expose the electronic system to high electrical voltages. This could damage the control system.
- Never immerse the controller in water or other liquid. This will make the controller unusable.

If your crane is equipped with add-on lifting equipment (hoist, rotator, etc.):

- The operation of the crane with add-on lifting equipment can differ from the operation as described in this manual.
- You should therefore study the Operating Manual for the add-on equipment carefully before you use the crane.
- Take particular note when placing the crane into or out of the transport position.

2. Structure and parts of the crane

2.1. Main groups

This HIAB crane consists of the following main groups:

- Crane base with column and slewing system
- Stabiliser system
- Boom system
- Operating system - hydraulic components

Some accessories can be fitted depending on your crane configuration:

- Add-on lifting accessories [option]
- Hooks [option]
- Separate lifting accessories [option]

2.2. Crane base with column and slewing system

The crane base, column and the slewing system consist of the following components:

- (1) Crane base
- (2) Stabiliser beam
- (3) Three-point bridge
- (4) Column
- (5) Rack and pinion slewing system.

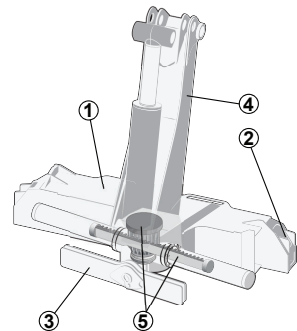

2.3. Stabiliser system

HIAB cranes (except stationary mounted) have two stabiliser extensions and two stabiliser legs. Auxiliary stabiliser systems may be needed for bigger cranes. The stabiliser system consists of:

- (1) Stabiliser beam
- (2) Stabiliser extensions
- (3) Stabiliser legs
- (4) Stabiliser locking devices [option]
- (5) Extra support plates

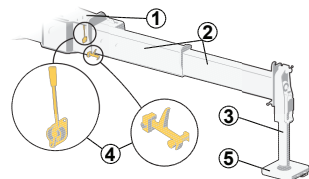

2.4. Boom system

The boom system consists of the following components:

- (1) 1st boom
- (2) 1st boom hydraulic extensions
- (3) 2nd boom
- (4) 2nd boom hydraulic extensions

The extensions are operated by hydraulic cylinders placed inside the extensions.

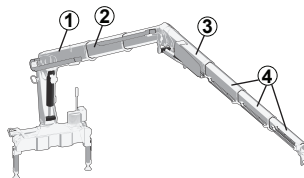

2.5. Accessories on the boom system

Add-on lifting accessories [option]

Add-on lifting accessories are placed between the boom tip and the load (e.g. brick grapple, rotator) or on the crane (e.g. hoist).

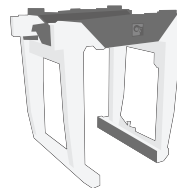

Hooks [option]

Different hooks can be mounted depending on the crane model.



DANGER

Never exceed the maximum permissible loading of the hook.

Separate lifting accessories [option]

Separate lifting accessories, help to make or use a slinging device: shackles, eye-bolts etc.



2.6. Operating system - hydraulic components

The operating system consists of the following hydraulic components:

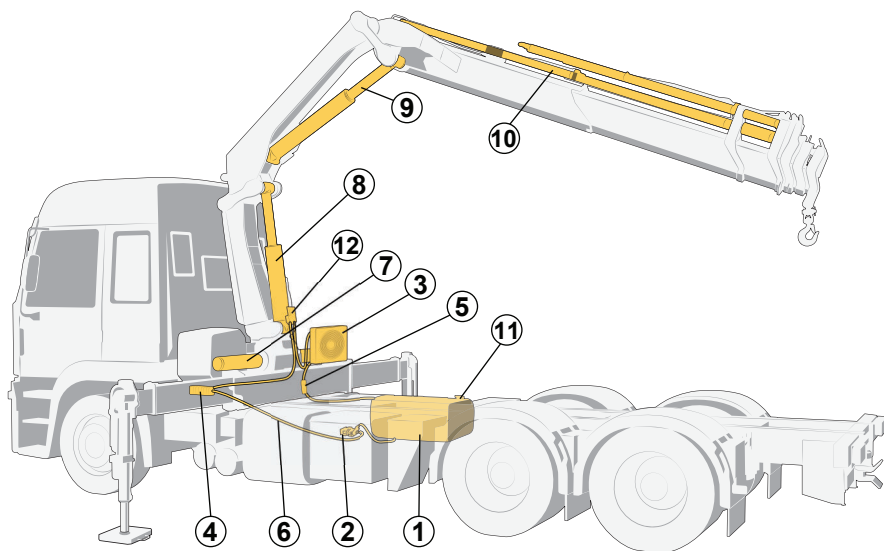

(1) Oil tank	(5) Stabiliser control valve [option]	(11) Return filter
(2) Hydraulic pump	(6) Hydraulic hoses and lines	(12) Load holding valve
(3) Oil cooler [option]	(7) Slewing cylinders / Slewing motors	Pressure filter [option]
(4) Main control valve	Actuators: (8) First boom cylinder (9) Second boom cylinder (10) Extension cylinder/s	

2.7. LHV Load holding valves

All cylinders are equipped with load-holding valves as a safety device. After a crane movement, they hold the crane in position, also in the unlikely event of a burst hose.

If there is a leak or a component fractures, such as a pipe, hose or coupling, the load-holding valves will stop the booms from collapsing down, even when the hydraulic system is switched off, and you operate a particular crane lever.

To operate a hydraulic cylinder equipped with a load holding valve, an opening pressure is required.

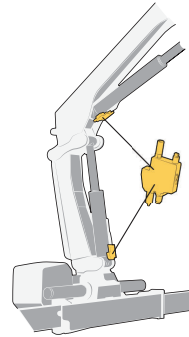

2.8. Description of HIAB K-HiPro 505

The HIAB K-HiPro 505 are compact, fully hydraulically operated goods cranes.

Stress history class S2 according to EN 13001-1.

Lifting capacity:

- HIAB K-HiPro 505 = 41 tonne metres (296 600 ft-lbs)

Outreach:

- HIAB K-HiPro 505-4 reach: 25.2 metres (82' 8" ft)

The control valve V200, a controller (CombiDrive or XSDrive) and the SPACE X4 safety system are standard equipment on the HIAB K-HiPro 505.

The crane type and the manufacturer are marked on the serial number plate.



NOTE

The exact technical information for your crane is shown in the Technical Data.

3. Safety precautions and warnings

3.1. Operating conditions

You may use the crane **ONLY** if:

- You are outdoors or in a space with sufficient ventilation.
- With a mean wind velocity of less than 13.3 m/sec (approx. 29.7 mph). **See the wind speed table.**



DANGER

- **Do not use** the crane in a confined space because you could suffocate from the exhaust gases from the vehicle.
- **Never** use the crane in a high wind or storm. When the mean wind velocity exceeds 13.3 m/sec (approx. 29.7 mph) the crane will behave unpredictably. **Never** use the crane during a thunderstorm.
- **Never** use the crane at temperatures below -30°C (-22°F), as the steel's properties deteriorate below this temperature.



WARNING

- At temperatures below 0°C (32°F), do not touch the operating levers during the first few minutes.
- In cold weather, the wear on the hydraulic system is greater than at normal working temperatures.

In cold weather, start the crane as follows:

- Engage the power take-off at low rpm.
- Allow the system to idle for a few minutes.
- Operate stabiliser legs up and down for one minute, in order to warm up the oil.



3.2. Wind speeds

Wind speed averaged over 10 minutes at a height of 10 m

Wind Force	Above flat ground		Characteristics
	m/s	Wind type	
0	0.0 - 0.2	Calm	Calm, smoke rises vertically or nearly vertically
1	0.3 - 1.5	Slight breeze	Wind direction recognisable from smoke plumes, the wind begins to be noticeable on the face; leaves begin to rustle and weather vanes can start to move.
2	1.6 - 3.3		
3	3.4 - 5.4	Moderate wind	Leaves and twigs in continuous movement, small branches begin to move. Dust and paper begin to move over the ground.
4	5.5 - 7.9		
5	8.0 - 10.7	Fairly strong wind	Small leaved branches make swaying movements; crested waves form on lakes and canals.
6	10.8 - 13.8	Strong wind	Large branches move; you can hear the wind whistling in telephone wires; umbrellas can only be held with difficulty.
7	13.9 - 17.1	Severe wind	Entire trees move; the wind causes difficulty when you walk into it.
8	17.2 - 20.7	Stormy wind	Twigs break off, walking is difficult.
9	20.8 - 24.4	Storm	Causes superficial damage to buildings (chimney pots, roof-tiles, and TV antennae are blown off).
10	24.5 - 28.4	Severe storm	Uprooted trees; considerable damage to buildings etc. (occurs infrequently on land).
11	28.5 - 32.6	Very severe storm	Causes extensive damage (occurs very infrequently on land).
12	> 32.6	Hurricane	

3.3. Definition of this loader crane

Usage of the crane

The HIAB loader crane is used to lift and move loads in the working area permitted by the load plate and the load diagram. The cranes are normally mounted on a vehicle but they can also be mounted on a fixed base plate. The crane can be equipped with a number of accessories.

Loader cranes are designed for loading and unloading the vehicle, as well as for other duties as specified:

Permitted duties:

- Loading and unloading cargo from/to a vehicle
- Lifting of loads from the ground/vehicle to a higher place
- Installation work (beams, concrete plates, windows...) in building constructions
- Lifting construction material (wall boards, bricks, blocks...) on a pallet fork to a building, taking the material from the vehicle on which the crane is mounted, from another vehicle or from the ground
- Hoisting, e.g. beams, concrete plates and any other material and equipment used in building construction
- Moving filling material at a construction site with a bucket
- Handling large loads (containers, boats, machinery, vehicles...)
- Collection of waste and recycling material (glass, paper, cardboard, plastic...)
- Installation of informative posts, road signs, notice boards, traffic lights, street lights...

Forbidden duties:

- Crane mounted onboard ships or floating structures, only permitted in cases authorised by Hiab
- Continuous use as a production crane in assembly lines, foundries..., except for cranes prepared for that purpose
- Handle loads, work with submerge boom system or accessories, in strong currents such as rivers
- Pressure against the ground, unless the crane is specifically prepared for this
- Pushing/pulling with the boom system against any type of obstacle (wall, ground...)
- Putting loads on structures if you do not know their resistance
- Lifting loads with the wrong side of the boom system

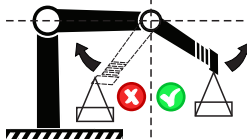

- Lifting a mass that is partially loaded or attached to another equipment/structure/element

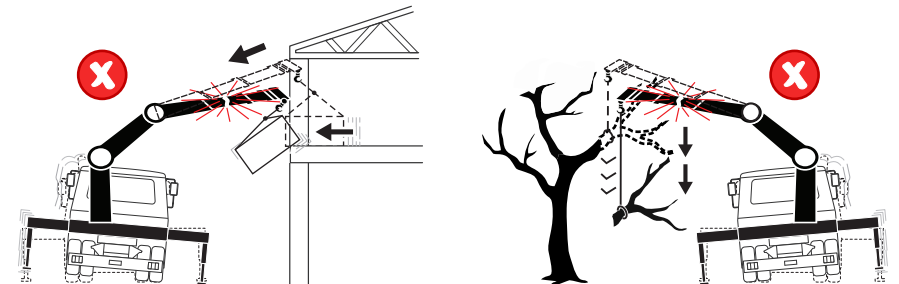

CAUTION

There is a risk of tipping the truck and/or damaging the crane, the load or other structures inside the working area.

metres that the crane can operate at different positions. The lifting capacity of your crane determines the maximum load your crane may lift within its working zone. However take careful note; the greater the operating radius of the crane, the lower the lifting capacity will be because of the weight of the boom system itself. The load plate and the load diagram on your crane show the maximum loads you may lift in the operating reach of your crane.



DANGER

- Overloading could result in damage to the crane or in the worst case, personal injury or death.
- Never increase a hanging load, since that may cause a load holding valve to open and/or the vehicle to turn over.
- Never use the crane with the OLP system switched off.



NOTE

The extra weight of the lifting accessories has to be added to the load. Thus, with lifting accessories the load you can lift is less heavy

Load plate

You will find the load plate next to the control valve. On the plate are shown two different situations with the maximum weight that you may lift at a given reach, with the 1st boom in the optimum position. In chapter Technical Data in this manual you will find these values for your crane.

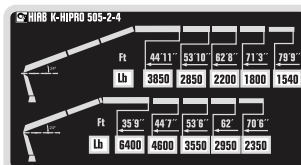

		Reach (Ft)				
Configuration 1	Ft	44'11"	53'10"	62'8"	71'3"	79'9"
	Lb	3850	2850	2200	1800	1540
Configuration 2	Ft	35'9"	44'7"	53'6"	62'	70'6"
	Lb	6400	4600	3550	2950	2350

Optimum position

The weight that your crane can lift will be determined by:

- Stability test of your crane on vehicle [if VSL as option]
- Stabiliser extensions positioned and legs pressed to ground.
- The reach at which you are working and the optimum position of the boom.
- The optimal position for your crane is on the load plate.



DANGER

Never exceed the maximum weight on the load plate.

Load diagram

The load diagrams are placed on the column and show the maximum loads your crane may lift in the entire working zone. The load diagram drawing will also be found in the enclosed Technical Data.

The white area is the working zone of the crane.

The load curves show the maximum load that may be lifted at a given reach and height. For a given maximum load, the possible working zone is to the left of the load curve. The lifting capacity for some cranes is limited in the high lifting area.

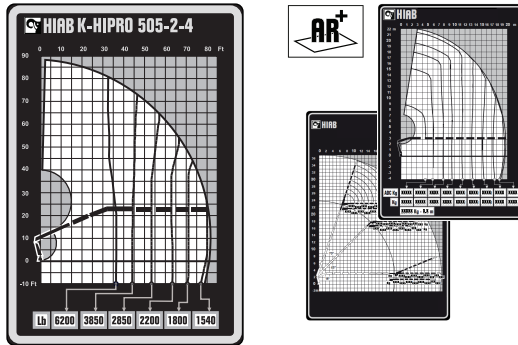

WARNING

Care must be taken when handling loads in the high lifting area, so the load/tool does not come into contact with the boom system.

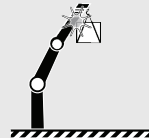

WARNING

Never operate the hydraulic extensions against a solid object when the first boom is completely lifted. Do not try to push or compress loads when the first boom is fully lifted, as this could cause damage to the first boom cylinder.



3.3.4. 2nd Boom dual capacity

Depending on the boom system angles, the capacity of the crane is optimized to get the best performance in each position.

You will get an extra capacity in the 2nd boom cylinder when the crane is working below $\alpha = 50^\circ$. This will allow greater outreaches for heavier loads.

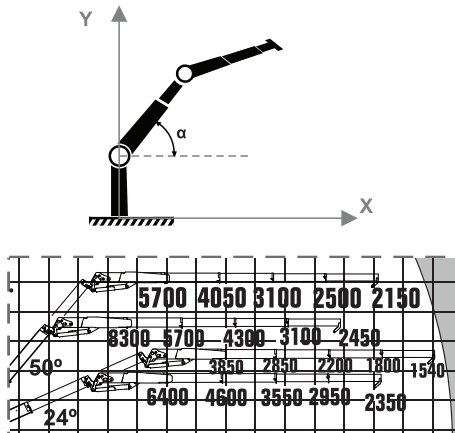
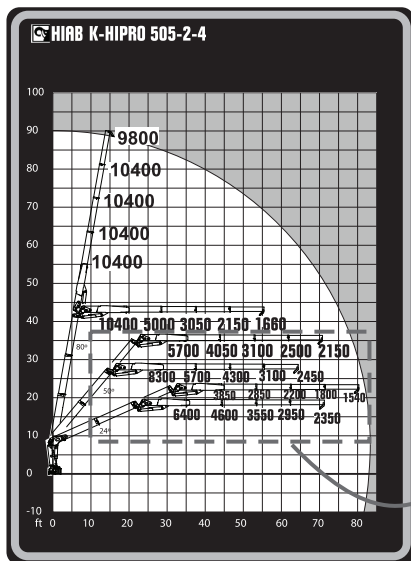

3.3.5. Maximum load moment

If your crane has reached the maximum load moment (lifting capacity), the OLP gives a warning and locks any crane movement that will increase the load moment. This is known as an OLP situation.

If the 2nd boom is raised, the following movements are locked:

- 1st boom down/up
- 2nd boom down
- extension boom out

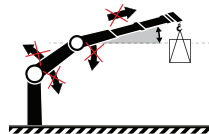

If the 2nd boom is down, the following movements are locked:

- 1st boom up
- 2nd boom up
- extension boom out
- 1st boom down (certain crane types and cases)

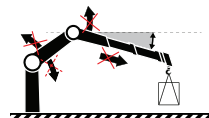

Lifting the load

Make sure that you always have the work in clear view. If you cannot see the load properly, you could cause a fatal accident or serious damage.

Sling length

Always attach the load using the shortest possible sling. The angle between the legs of the sling must not exceed 120°. The maximum working load, (usually known as the working load limit (WLL) in standards) of a multi-legged sling for general purposes, is calculated by multiplying the WLL of a single leg by a mode factor (refer to the table).

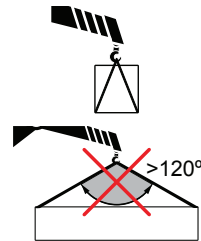

Max angle to the vertical of any sling leg (degrees)	Mode factor two legged sling	Mode factor three and four legged sling
0-45	1.4	2.1
45-60	1.0	1.5

If the angle between the legs of the sling is more than 90°, do not hang the slings directly on the hook. Use a ring hanging from the hook to attach the sling.

Working close to the load

Always try to lift the load with the extension boom retracted, however not completely. The crane then has the greatest lifting capacity. Place the vehicle as close as possible to the load.

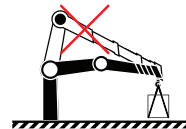

Working below ground level

If you have to load or unload below the level of the ground: keep the 1st boom angle to about 10 to 30° above the horizontal plane.



Heavy loads

Lift heavy loads with the 2nd boom in the optimum position in relation to the 1st boom. For this, see the load plate on your crane.

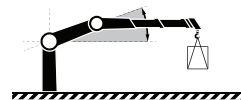

DANGER

Never exceed the maximum permissible loading of the hook.

Heavy loads cannot be handled with the boom straight.

Set the 2nd boom, so there is an angle in relation to the 1st boom.

Loads at the extreme limit of the working zone

Also in this case, angle down the 2nd boom somewhat. Only use the 1st boom .

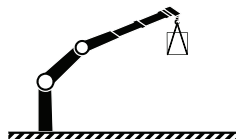
**TIP**

Make smooth crane movements: operate the crane with various functions simultaneously. In this way you will also prevent the hydraulic system heating up quickly.

3.4. Signals when using a crane [AR+]

**DANGER**

- If it is not possible to see the load and the entire working area clearly the crane operator is obliged to follow the instructions and signals given by a qualified person qualified.
- The country-specific regulations for crane operator signals are to be used.

Signals in this manual give a number of standard signals that can be used.

Lift

Raised arm and index finger raised. Circular motion with the hand.

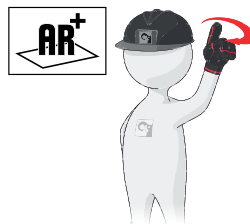
**Lower**

Arm pointing downwards and index finger down. Circular motion with the hand.



Stop all crane movements / Hold the load in position

Raise the open hand, with the palm clearly visible, and arm at shoulder height.

Keep the hand still.



Emergency stop for all movements by the crane

Raise the hands and the arms to an oblique angle.



Very short movement

Place the hands a very short distance apart, with the palms facing each other. The hands may be held either horizontally or vertically. The next movement may be: Lift, lower, move the lifting gear, change the reach, or turn.



Change the reach

Signal with your hands.

- Sideways movement outwards with both hands. Thumbs outwards.
- Sideways movement inwards with both hands. Thumbs inwards.

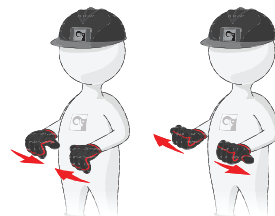

Turn in the direction indicated

Indicate the direction with the hands.

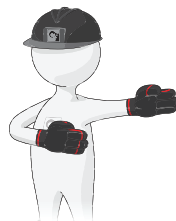
**Open the tool**

Extend the arms at shoulder height, with the palms facing downwards.

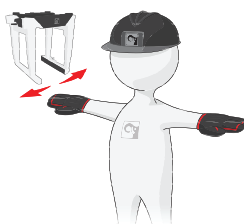
**Close the tool**

Move both hands close together.

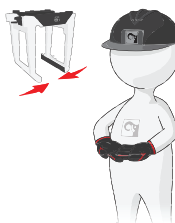
**Lift the open tool a little**

Extend both arms at shoulder height, with the palms facing upwards. Make vertical movements with both arms outstretched.

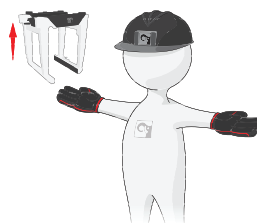

Keep the tool in position briefly

Raise the hand drooping slightly, with the fist clenched.



3.5. Use of the crane

Starting crane operation



DANGER

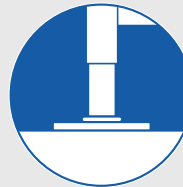

- Make sure that you comply with the regulations of the country in which you use the crane (for example, certificate, safety helmet, and other personal protection devices).
- Check that the ground is sufficiently flat and firm.
- Verify that the ground is not uneven. Be careful with sewers, cellars, excavations etc.
- To make sure that the vehicle stays in its position, always engage the parking brake and place chocks under the wheels.
- Lower the stabiliser legs only on to a flat and firm surface.
- Do not lower the stabiliser legs on the edge of an embankment, soft shoulder, slope etc.
- Make sure that you can see the stabiliser legs and stabiliser extensions when you are operating them.
- The stabiliser legs must not sink in! Use support plates that are large and firm enough for your crane. The plates must not bend because of the load weight.
- Verify that the support plates do not sink as you gradually lift the load.

**DANGER**

- Do not stand in front of the hydraulically operated stabiliser legs when you are operating them!
- Never use the stabiliser legs as a parking brake, since the vehicle could start to slide.
- Slide the stabiliser extension, on both sides of the vehicle, completely out if possible. Then lower the stabiliser legs for support.
- Never operate the stabiliser legs/ extensions if there is a load suspended from the crane.

**WARNING**

- Use low force when you put the stabiliser legs on the ground.
- Do not raise the vehicle with the stabiliser legs! If you do, you can cause damage to the stabiliser legs.
- Check that the add-on lifting accessories and separate lifting accessories are in good condition!
Add-on lifting accessories are sometimes attached to the crane (hoist, JIB) or on the boom tip (grapple, rotator).
Separate lifting accessories are connected to the standard load hook (slings, chains, shackles etc).

**DANGER**

Do not stand in front of the boom system when operating the crane out of transport position.

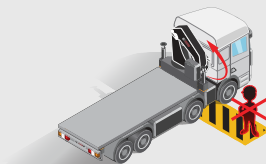

3.5.1. Preparations for use



DANGER

Make sure that there are no unauthorised persons within the operating range of your crane!

To mark the working area correctly, think about the space that the crane will need to lift the load (direction of the lift, size of the load).

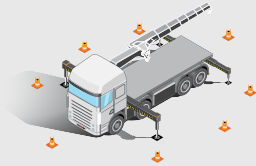

CAUTION

- Put on your vehicle's warning lights.
- Make sure that the parked truck does not block emergency exits, pedestrian roads or no-parking zones unless you have permission.
- Make sure that both the truck and the crane do not block the visibility of important signs for other users of the area (for example, road signs).



DANGER

- If a part of the crane comes in contact with an electricity line, you will be electrocuted!
- Always keep the following minimum distances between the crane and overhead electricity lines, unless otherwise prescribed by national rules.

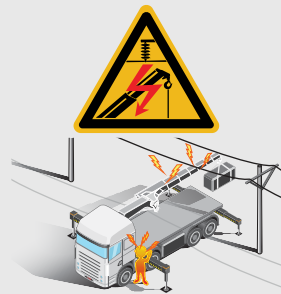

Minimum distance between crane and overhead electricity lines		
Voltage (V)	Minimum distance to an insulated conductor	Minimum distance to an uninsulated conductor
<500 V	0.5 m	2 m
500-40000 V	1.5 m	4 m
>40000 V	2.0 m	6 m
Voltages are found:		
up to 500 V:		to buildings
500-40000 V:		trams, trains
over 40000 V:		power transmission



DANGER

When you go into the control station (high-seat, cabin, platform) remove all jewellery, loose clothing, or other hanging items from your body (for example, rings, scarfs, bracelets...). Jewellery, loose clothes, and other hanging items can be caught in some parts of the crane.



DANGER

When you go into or out from the control station, use only handles and supports on the crane that were specifically made to help the operator to go into or out from the control station.



WARNING

Make sure that you know the position of all the emergency stop buttons on your crane and on the controller.

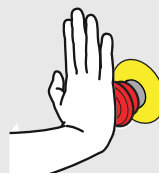

3.5.2. Crane operation



DANGER

Your crane has a control system.

The control system will help you to work safely. Nevertheless, you remain responsible for safe use of the crane!

Therefore, always work according to the operating instructions!

In an emergency situation, push immediately any of the emergency stop buttons. This will stop all crane movements and prevent the free movement of the load.



DANGER

- Keep checking that there are no unauthorised persons within the operating reach of the crane!
- Make certain that you can always see the load!

If your view of the load is not adequate, have someone else give you signals.

See the list of signals. Make certain that you and the person assisting you know these signals.

- Pay attention to the safety of the person giving the signals!
- Never move the vehicle, if you have a freely-suspended load on the crane!
- Never walk or stand under a suspended load!

During operation, never stand below the boom system or load!

- Do not slew the crane, nor lift the first boom, nor lift the second boom into their ends positions at full speed. This can damage the crane.





WARNING

- Never push a load along the ground, or the vehicle's load space, with the extension boom. This can cause damage to the boom system. This will lead to expensive repairs.
- Never use the extension boom as a jack. This could damage the slewing bearings and the connection between the crane column and the crane base.
- Always lift the load from the ground before you start to slew. Do not tow the load over the ground. This can damage the boom system.
- If you are working with loads in restricted spaces (for example, windows):
Check that the boom system can move up and down freely.
The boom system will bend somewhat, when loading and unloading the crane.
- If the boom system is in a high position (first boom above 70°), do not allow the boom to lower at full speed. The crane could go into an uncontrolled movement.
Be careful if, in particular, the OLP gives an early warning!
- When loading the vehicle:
Take the load off the stabiliser legs by withdrawing them slightly. The stabiliser legs must remain in light contact with the ground.

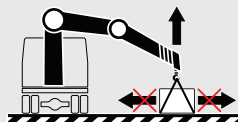

CAUTION

- Operate the crane using smooth and gentle lever movements.
- If a cylinder is at its end position, free the operating lever. Otherwise overheating can occur.

Precautions when slewing the crane

Your crane has a rack-and-pinion slewing system which provides more than 360° of rotation.

As part of the initial orientation and training:

1. Look at the plate(s) on the column to see the position of the 'slewing stop' (slewing stops).



NOTE

The exact positions for your crane can change from the image below.

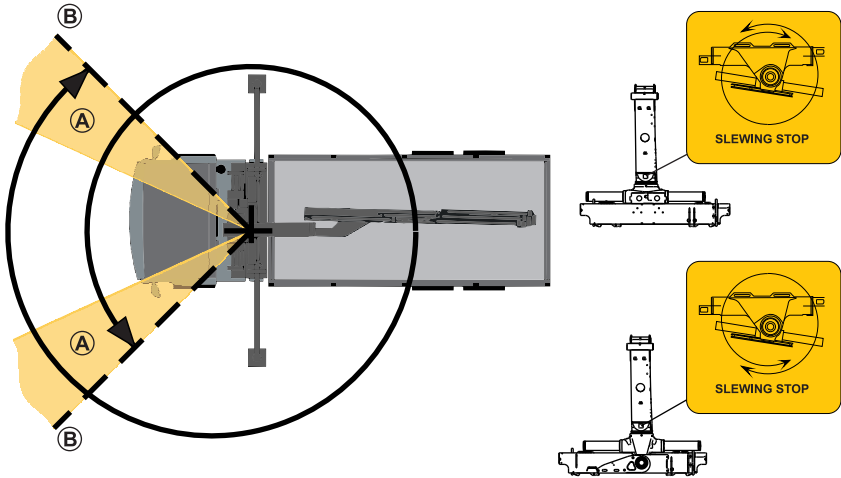

2. Slew the crane slowly in each direction to the slewing stop **(B)**.
3. Record the slewing stop positions.



CAUTION

To prevent damage to your crane base, reduce the slewing speed in the area **(A)** before reaching the slewing stops **(B)**.



NOTE

Remote controlled cranes with a slewing sensor will reduce the slewing speed automatically in the area **(A)**, but they will not stop automatically before reaching the slewing stops **(B)**.

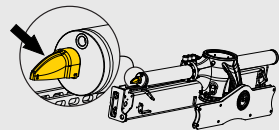

CAUTION

Repeated rotation of the crane against the slewing stops during operation can cause major crane base damage. If this operation happens, it will be considered as a misuse of the crane.

Working with the 2nd boom system

Try to avoid all the vertical and negative 2nd boom angles (more than -85°) when lifting, especially in close range positions.

If vertical and negative 2nd boom angles are not avoided, the resulting angle between the hydraulic fork attachment and the boom tip can lead to collision between the boom tip and rotator/hoses.

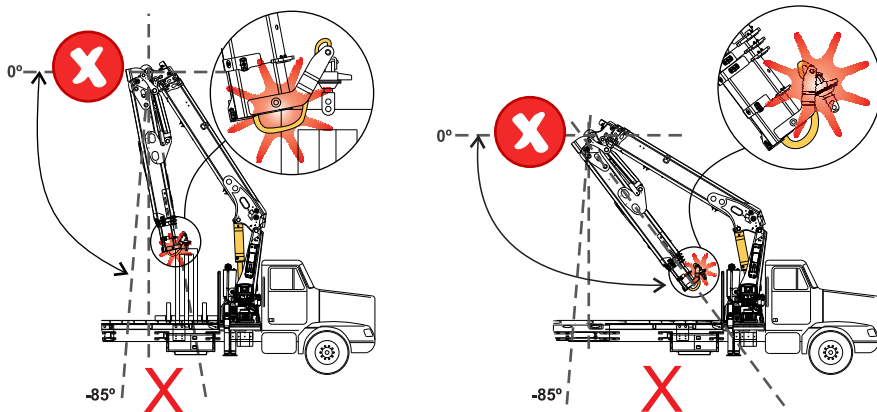

To avoid possible collision between the boom tip and rotator/hoses:

1. Elevate the 1st boom as necessary (nearly full elevation in close range positions).
2. Use the 2nd boom extensions to reach the position needed.

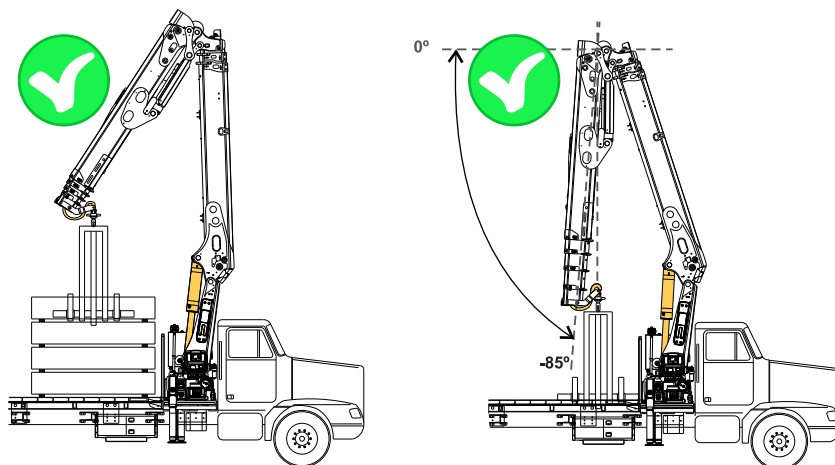

3.5.3. Driving with the crane



DANGER

- Never move/drive the vehicle if there is a load suspended from the crane.
- Before you move the vehicle:
Check that there is no pump flow to the main control valve. The PTO or power supply must be disengaged. The operating system must be switched off!
- Pay attention to the width and height of the crane in the transport position. The crane must stay within the width of the truck.
- Make sure the stowed crane and its accessories cannot fall, hit bridges, tunnels, other vehicles etc.
- Pay attention to overhead power lines! Make sure that no part of the crane ever comes in contact with overhead power lines.

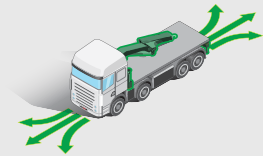

NOTE

- For further instructions, refer to the vehicle's manual(s).
- Make sure that you always obey local traffic rules when driving with a crane.

3.5.4. Use of lifting equipment



DANGER

- Only use lifting accessories (hoist, grapple, rotator) suitable for your crane. Contact a Hiab authorised service workshop.
- Never attempt to install add-on lifting accessories yourself!
- Add-on lifting accessories may only be installed by a Hiab authorised service workshop.
- When using lifting accessories, follow the instructions supplied with the equipment!
- Watch out for hazards!
- Never try to adjust lifting accessories when you are working on the crane!

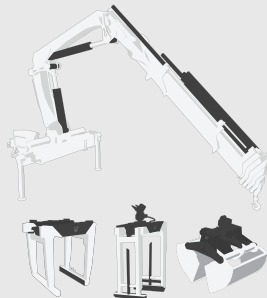

After the lifting accessories have been fitted:

1. Check that the lifting accessories are securely fixed.
2. Only after this should you use your crane.



WARNING

Always insert the locking pin in the shaft for all the attachments on the tip of the crane (hook, top-roller, pulleys...).

Do it in the same direction as shown in the picture.

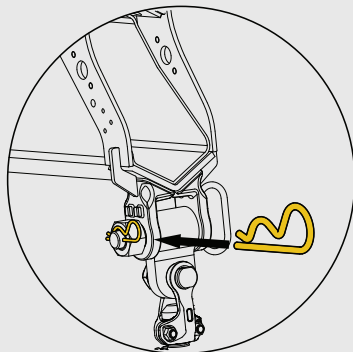

WARNING

If you attach/detach equipment to/from the tip of the crane and the boom system is not in horizontal position, stay away to avoid getting caught between the boom extensions as it is normal that they can move towards each other.

**WARNING**

- Clean the couplings, when connecting and disconnecting lifting accessories. Dirt can damage the hydraulic system.
- Take care that your fingers are not trapped

3.5.5. Use of demountable cranes**DANGER**

- Make sure that there are no unauthorised persons in the immediate vicinity of the crane. When mounting/demounting the crane on/from the vehicle, people can suffer fatal crushing injuries!
- After setting up, verify that the crane is properly locked!

**WARNING**

Be careful when mounting/demounting the crane on/from the vehicle as rough handling can seriously damage the crane or the vehicle.

3.5.6. Ending crane operation**DANGER**

Always end crane operation as follows:

- After use, always place the crane in the transport position!
- Withdraw the stabiliser legs and stabiliser extensions.
- Check that the locking mechanisms are properly locked.
- Switch off the operating system.
- Disengage the PTO or power supply after work.
- If you drive with the PTO or power supply engaged, this will cause serious damage to the PTO/gearbox combination.
- Only after doing the above, you can drive the vehicle away.

4. The HiPro system

4.1. Control System SPACE X4

SPACE X4 is a crane control system.

The control system:

- Monitors the crane's operation and prevents unsafe actions.
- Increases the precision with which you can work.
- Makes operation easier.
- Makes troubleshooting easier.

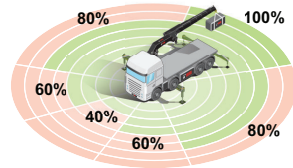

Crane version	Control valve	Control System	Controller
HiPro	V200	SPACE X4	CombiDrive XSDrive: Levers / Joysticks



NOTE

The control system provides a large number of functions. Certain features are standard, others are options.

If you do not use the system for 30 minutes, it will switch itself off in order to prevent draining the truck battery. This feature can be cancelled.

Contact your Hiab authorised service workshop.

4.2. How the safety system works

On the crane there are various sensors and indicators which send signals about the crane's load, position and movements to a central microprocessor. The microprocessor then decides how the crane can be operated and stops/reduces prohibited movements/speeds according to the following:

- When prohibited movements/speeds are approached, a warning is given.
- When prohibited movements/speeds are reached:
 - On remote controlled cranes prohibited movements are stopped.
 - On manually operated cranes, all movements are stopped, because when a spool is moved too much, power to the dump valve is cut, all movements are stopped.

Fault monitoring

When there is a fault in the control system it will give an immediate warning.

Depending upon the fault the crane speed and/or the load capacity will be reduced. When the fault is serious, use of the crane is blocked completely.



DANGER

Never try to repair the control system yourself. Repairs may only be made by a Hiab authorised service workshop!

4.3. Components of the HiPro system

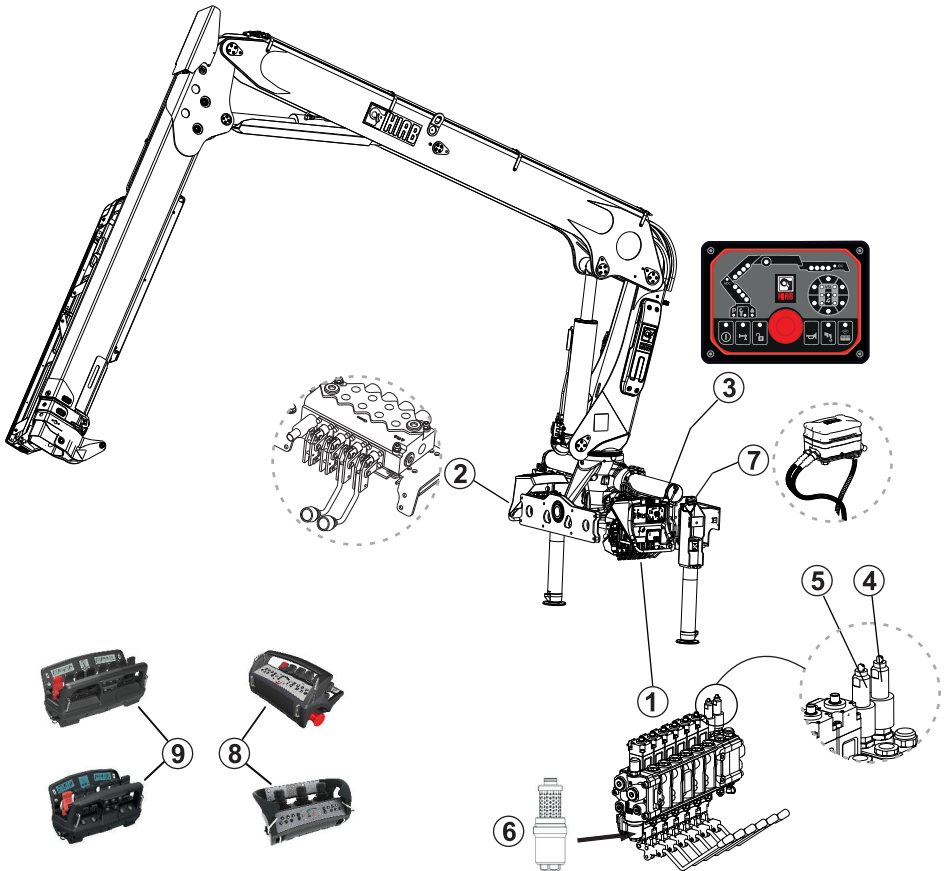

(1) Main control valve	(4) Dump valve 1	(7) Warning lamp
(2) Stabiliser control valve	(5) Dump valve 2 [option]	(8) XSDrive controller [option]
(3) User panel SPACE X4-UI	(6) Pressure-reducer filter	(9) CombiDrive controller [option]

4.4. Standard symbols and functions of the crane and the stabiliser system

These symbols can be shown:

- On the plates.
- On the control valve levers.
- On the controller (If delivered).



NOTE

If you use a controller to operate your crane, you can read about the symbols displayed on it in the dedicated section of this operator's manual.

By default, the symbol on the controller corresponds to the positive movement of the levers. To operate the opposite movement of that symbol, move the lever on the opposite direction.

Always operate the lever according to the function on the symbol sign.

Basic crane symbols and functions

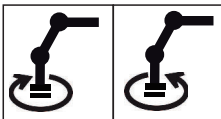
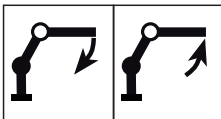
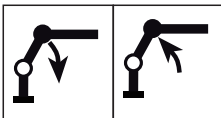
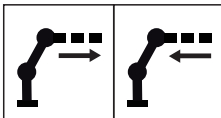
SYMBOLS		FUNCTIONS	SYMBOLS		FUNCTIONS
		Slewing			Second boom
		First boom			Hydraulic extensions

Accessories symbols and functions. (If delivered).

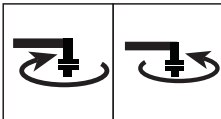
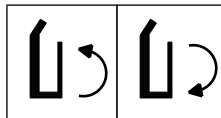
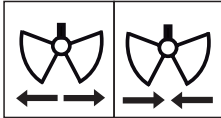
SYMBOLS		FUNCTIONS	SYMBOLS		FUNCTIONS
		Rotation tool			Tool
		Tool			

Stabiliser system symbols and functions (if delivered)

SYMBOLS	FUNCTIONS	SYMBOLS	FUNCTIONS
	Crane stabiliser extension		Crane stabiliser leg
	Auxiliary stabiliser extension		Auxiliary stabiliser leg

4.5. Main control valve

The crane can be operated from the main control valve, but as soon as you have selected remote control operation, it is impossible to operate the main control valve levers.

The speed of a function corresponds to the extent of the lever movement, regardless of the load and other functions, as long as the oil flow is sufficient. When the oil flow is insufficient, one or more functions might reduce their speed.

When remote control is used, the oil flow is allocated by means of PFD.

Standard functions and symbols

The order of the functions is customized for each crane. The image on the right shows an example of a main control valve functions placed on the base.

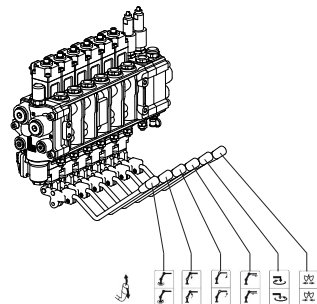

4.6. Different stabiliser control valves

Different stabiliser control valves that you can find on cranes:

- 2-function/4-function control valve included in the main control valve
- 2-function control valve
- 4-function control valve.

You can operate the stabiliser control valve manually or remotely. On remote-controlled cranes the stabiliser control valve levers are only to be used for emergency operation.

4.7. User panel





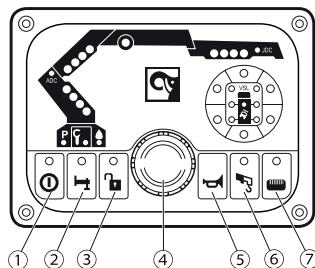



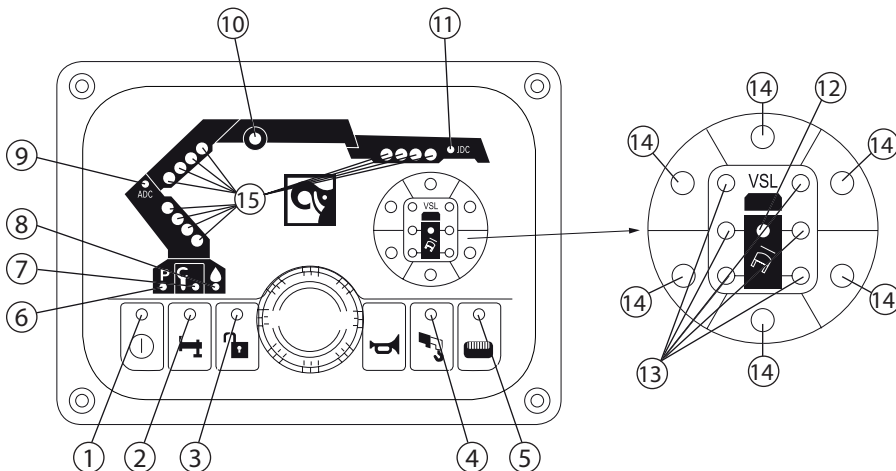















Buttons:

- On/off button (1)
To switch the control system on and off.
- Button (2) is stabiliser operation activation to enable operation of stabiliser extensions. The driver must have full view when operating the stabiliser extensions outward.
- Button (3) is used for OLP release if the crane is in an OLP situation and for disconnecting the automatic dump function.
- Stop button (4) is pushed in an emergency.
- Button (5) is used to sound the crane horn.
- Button (6) activates OLP for manual extensions (if fitted).
- Button (7) activates the controller.



4.7.1. Indicator LEDs on User Interface



	Power on/off APO	(1)	<ul style="list-style-type: none">  Green light on: The system is on.  Green light blinking: System on and the stop button has been pressed.  Green light flashing: APO emergency operation time running.  Red light flashing: CAN communication has been lost/ APO override time running
	Stabiliser system activation	(2)	<ul style="list-style-type: none">  Green light on: Stabiliser system active.  Green light flashing: Stabiliser extension is in locked position.
	OLP Release	(3)	<ul style="list-style-type: none">  Red light blinking: OLP Release active (crane, VSL or stabiliser leg)  Green light flashing: Critical error.
	Manual extensions	(4)	Not active in this configuration.
	Remote control	(5)	<ul style="list-style-type: none">  Green light on: Remote control is active.  Green light flashing: Button for remote control has been pressed, waiting for connection to hand unit.  Red light on: Radio interference.
P	Parking control	(6)	 Blue light on: Slew is in parking position.
	Service	(7)	<ul style="list-style-type: none">  Green light on: Service needed.  Red light on: Error in the system.  Red light blinking: Critical error.
	Dump valve	(8)	 Blue light on: Dump activated.
ADC	ADC	(9)	 Blue light on: Indicates that the ADC feature is active.
	Hoist	(10)	Not active in this configuration.
JDC	JDC	(11)	Not active in this configuration.
	VSL	(12)	 VSL-OLP reached.

	Stabiliser legs	(13)	<ul style="list-style-type: none"> ● Green light on: Stabiliser leg set. ● Red light on: OLP stabiliser leg.
	Stability sector (Cranes with VSL function)	(14)	<ul style="list-style-type: none"> ● Red light on: 0-19% stability. ○ LED off: 20-69% stability. ● Yellow light on: 70-89% stability. ● Green light on: 90-100% stability.
	Stability sector (Cranes without VSL function)	(14)	<ul style="list-style-type: none"> ● Green light on: regardless of the situation.
	Cylinder pressure	(15)	<ul style="list-style-type: none"> ● 1 of 4 green light on: 50% pressure. ● 2 of 4 green light on: 70% pressure. ● 3 of 4 red blinking light: 90% pressure. ● 4 of 4 red light on: 100% pressure. ● 4 of 4 red running light: OLP release activated.

LED test, see Daily inspection.

4.8. Dump valves

Dump valve 1. (1)

Allows operation of the crane functions. To prevent high pressure and thereby unnecessary heating of the oil there is an automatic dumping function. When no lever movement has been made for 3 seconds the dump valve is opened and the oil is returned directly to the hydraulic tank. As soon as the operator moves a lever the valve closes.

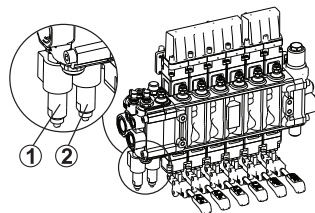

Dump valve 2. (2)

Allows operation of the stabiliser extensions and legs only when this valve is activated. The dump valve 2 will be placed between the main control valve and the stabiliser control valve. The dump valve 2 must be activated from the User Interface before the stabiliser system can be controlled.

4.9. Pressure-reducer filter

Pressure-reducer filter integrated in the main control valve. The oil goes through the filter and then to the positioner(s).

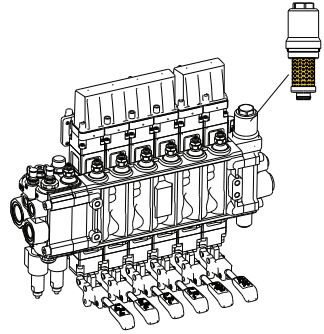

4.10. Warning lamps

A warning lamp on each stabiliser leg is used to warn the surrounding about ongoing activity, by amber light indication. A warning lamp also gives information to the operator about the different statuses of the crane.

System ON: the stabiliser leg lamps light up

Remote control ON: the stabiliser leg lamps blink

90% of maximum permitted load and OLP: the stabiliser leg lamps flash twice

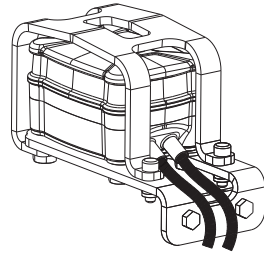

4.11. XSDrive controller

Controller XSDrive has either four or six levers, or two or three joysticks for proportional functions programmed in the different menu selections. The controller normally communicates with the crane via radio but can also be operated via cable.

Radio communication is dependent on:

- Transmitter, fitted in the controller.
- Receiver box, fitted on the operating base.

The Receiver box consists of a combined radio receiver and 12 outputs for servo valves. The status of the receiver is visible on the controller. In case of radio interference, it is possible to change the channel by pushing button . There is a maximum of 12 channels available.



**WARNING**

When the controller is in use (stop button released), keep a distance of minimum 1 meter between the controller and the crane or truck because of possible electromagnetic interference.

Cable connection [option]

The cable (2) is intended to be used for short-term operation and when pairing in conjunction with the replacement of controller or receiver. Connection is made between the controller (3) and the receiver box (1). Radio communication is automatically disabled when the cable is connected.

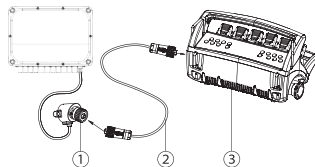

4.11.1. Indicator LEDs on XSDrive controller

The indicator LEDs on the controller indicates errors, stability, cylinder pressure etc. The appearance of the panel differs somewhat depending on if the controller has levers or joysticks.

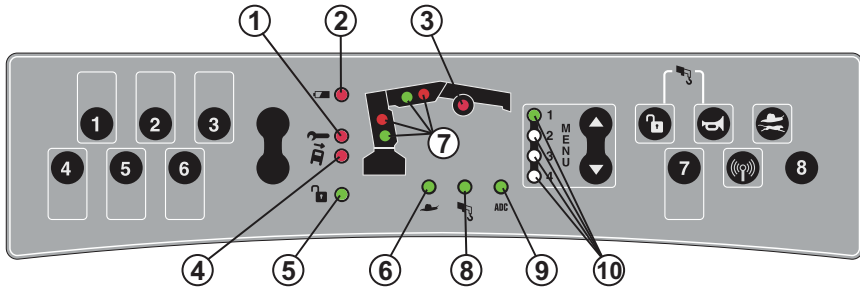

	Service	(1)	<ul style="list-style-type: none"> Red light on: Error detected in the system.
	Battery	(2)	<ul style="list-style-type: none"> Red light on: Low power
	Hoist LED	(3)	Not active in this configuration.
	VSL	(4)	<ul style="list-style-type: none"> Red light on: VSL-OLP. Vehicle has reached a stability limit. (Also all the 1st boom diodes will light red).
	OLP Release	(5)	<ul style="list-style-type: none"> Red light on: OLP Red light blinking: OLP Release.
	Low speed	(6)	<ul style="list-style-type: none"> Green light on: Reduced speed. For normal speed, see section "Buttons"
	Cylinder pressure LEDs	(7)	<ul style="list-style-type: none"> Lower LEDs green light on: 70% of maximum pressure Lower LEDs, red light flashing: 90% of maximum pressure Lower and upper LEDs red light: 100% of maximum pressure
	Manual extension	(8)	Not active in this configuration.
ADC	ADC	(9)	<ul style="list-style-type: none"> Green light on: Increased capacity (ADC mode)
	Menu LEDs	(10)	<ul style="list-style-type: none"> Light on: Indicates active menu

4.11.2. Buttons

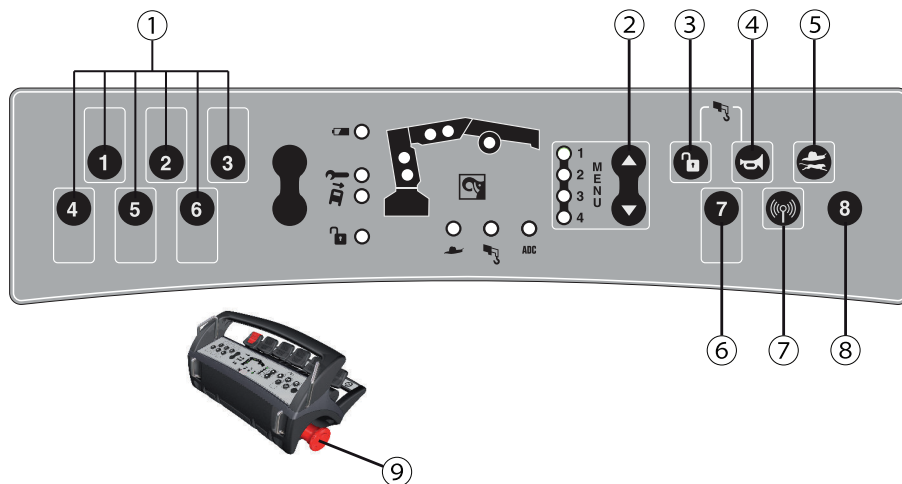

(1)	ON/OFF buttons	Buttons for 7 extra ON/OFF functions (engine on/off, engine speed, horn etc.)
(2)	Menu selection	Push to change between menus 1 to 4.
(3)	OLP release	Push and hold the button while you operate a pressure reducing function.
(4)	Horn	Push to operate the horn.
(3) & (4)	Manual extensions	Push at the same time to activate the manual extension.
(5)	Speed selection	At the start, you have maximum operational speed. Push the button to operate the crane with decreased speed. Push it again for maximum speed.
(6) & (8)	LSS-V	If the crane has LSS-V, button (6) activates this feature and button (8) deactivates it.
(7)	Channel shift	Push to change radio channel. There are 12 channels in total.
(9)	Emergency stop button	When you push the button, you stop all crane functions. To release it, turn the button clockwise.

Locking the controller

1. Push the emergency stop button.
2. Push and hold both arrows on the toggle button and release the emergency stop button at the same time.
3. The 4 LEDs flash at the same time.
Now you cannot operate the controller.
4. Push the emergency stop button.

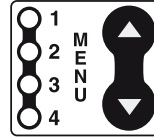

Unlocking the controller

1. Make sure that you pushed the emergency stop button.
2. Push and hold both arrows on the toggle button and release the emergency stop button at the same time.
3. The 4 LEDs flash at the same time for 5 times.
4. LED 1 comes on. (Start menu)

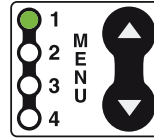

4.11.3. Menus

The functions presented in each menu can be customized depending on crane configuration. It can be changed by a Hiab Authorized Workshop.

The table below shows an example:

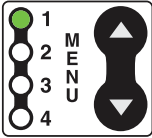
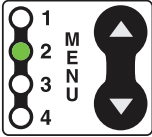
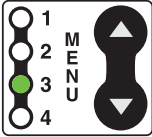
<p style="text-align: center;">Menu 1</p> 	<p>Slewing, first boom, second boom, extension boom, tools JIB, hoist, etc.</p>
<p style="text-align: center;">Menu 2</p> 	<p>[option] (If crane is equipped with extra remote controlled stabiliser system)</p>
<p style="text-align: center;">Menu 3</p> 	<p>[option] Slewing, attachment. (If crane is equipped with remote controlled stabiliser): left and right stabiliser extension, left and right stabiliser leg.</p>

<p style="text-align: center;">Menu 4</p>	<p>[option] Similar to menu 3 but for extra stabiliser legs</p>
--	---

4.11.4. Standard functions and symbols

The function corresponding to each lever depends on the configuration of the specific crane. The table below shows examples:

Controller XSDrive levers

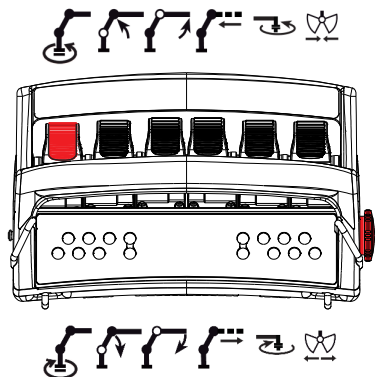

Controller XSDrive joystick 3-0-3

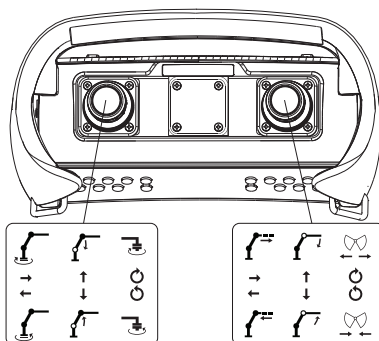

Controller XSDrive joystick 2-2-2

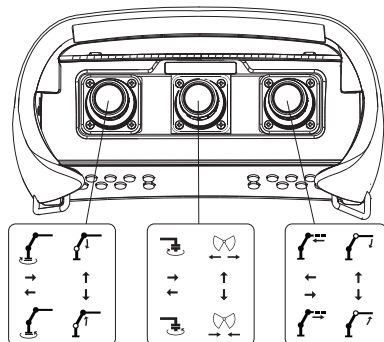

Controller XSDrive joystick 3-2-3

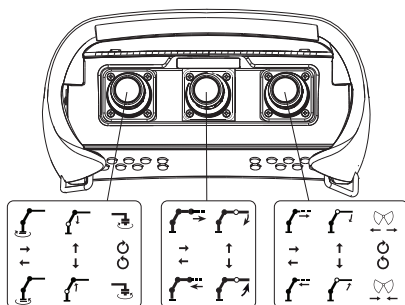

4.11.5. Battery and battery charger XSDrive

Battery

A fully charged battery provides approximately 5-8 hours use (at 25 °C, 77 °F) and the voltage level is approximately 8.4 V. When the battery is about to wear out an indicator LED on the controller flashes steady red and the horn will sound twice. Push the emergency stop button before changing the battery. Note that the battery voltage remains between 7.6 V and 7.5 V for a long time. Therefore, the battery voltage cannot be used to estimate remaining hours of use.

Battery charger

The battery charger is to be fitted in a protected environment, preferably in the cab.

LED (1) is lit continuously when the battery charger is ready for use. Place the battery in the charger. LED (2) flashes slowly during recharging and has a steady light when the battery is fully charged.

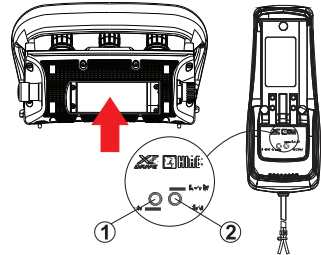

Charging time

The normal charging time for a flat battery, is approximately 3 hours. Operating ambient temp: Battery = 0° to + 45°C.



NOTE

A charged battery is a concentrated energy source. Never store a charged battery in a toolbox or similar, where there is a risk of a short due to contact with metal components. Used batteries should be taken care of according to the local regulations.

4.12. CombiDrive controller

The controller has either six or eight levers. Normally the controller operates wirelessly via radio but it can also be operated via cable. The controller is equipped with a menu selection system as standard. The displays continuously provide the operator with information.



Radio communication is dependent on:

- Radio for two-way communication fitted in the controller.
- Radio/decoder fitted at the crane base.

Information can be sent both from and to the controller. In the decoder/radio there is a corresponding unit which handles the traffic at the other end.



Cable connection:

A four-metre cable is supplied as standard with The controller. The cable is intended to be used for short-term operation and when pairing in conjunction with the replacement of controller or decoder. The cable connects to the vehicle at the connector (1) on the front of the decoder.

When the cable is connected to the controller (2), the centre display shows the symbol for cable operation.



4.12.1. Displays

The displays are of LCD-type and will perform best in temperatures above +10 °C. At 0 °C there is a delay in shifting symbols of approximately 1 sec. At -20 °C the delay will increase to approximately 8 sec. Alternating symbols will not be updated at temperatures below freezing.





In order to prevent inaccurate menu shifts, in temperatures below -10 °C there will be a delay before any menu button will react to a second press. This can partly be avoided by storing the controller in a compartment where the temperature exceeds +10 °C whenever not in use.

Centre display

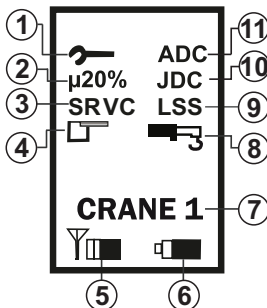
The center display provides information about which menu has been chosen, as well as indicating for example radio reception, battery status, fault information, ADC and VSL.

Indications on the centre display



	<p>(1) Error</p> <p>This symbol, a spanner, appears if the control system, has discovered a fault in the system. See section “Buttons” for error code display.</p> <p>Non critical error: Symbol appears enlarged in the center of the display and then returns to normal size in the upper part of the display.</p> <p>Critical error: Symbol remains enlarged in the center of the display. The crane stops. To continue, the fault must first be confirmed by pressing the release button, only then will the spanner go back to normal size.</p>		
<p>μ20%</p>	<p>(2) Micro</p> <p>Indicates that micro operation has been selected. Micro operation changes the sensitivity of the levers as follows: At full lever deflection, μ50% gives 50% and μ20% gives 20% of normal speed.</p>	<p>(7) Main menu</p> <p>The text shows which main menu has been selected. The number shows which sub-menu is active. The main menus are CRANE, EXTRA and ON-OFF.</p>	<p>CRANE 1 EXTRA 2 ON-OFF 2</p>
<p>SRVC</p>	<p>(3) SRVC</p> <p>Indicates time for service. When remote control is first engaged, the symbol will be shown enlarged and then return to normal size.</p>	<p>(8) Manual extension</p> <p>Manual extension is selected by pressing the horn and release buttons at the same time. The control system acknowledges by showing this symbol.</p>	
	<p>(4) MEWP (Mobile Elevating Work Platform)</p> <p>Indicates that MEWP mode (if present) is active.</p>	<p>(9) LSS (Load Stabilizing System)</p> <p>Indicates that the LSS-V function is active.</p>	<p>LSS</p>
	<p>(5) Signal strength</p> <p>The bars show the radio signal strength. Five bars indicate optimum reception. If the symbol flashes, the radio is connected but starting conditions are not met.</p>	<p>(10) JDC</p> <p>Indicates that the JDC function is active.</p>	<p>JDC</p>
	<p>(6) Battery capacity</p> <p>The battery symbol shows remaining power in the battery. When the symbol begins to flash there is capacity for just a few more minutes. When this happens the horn on the crane will sound twice as an indication of low battery.</p>	<p>(11) ADC (Automatic Duty Control)</p> <p>Indicates that the ADC function is active.</p>	<p>ADC</p>

Left and right displays

The side displays show the symbol for the function which each lever controls in the active menu. Function symbols change according to which menu has been activated. The direction shown in the function symbols applies to when the lever is moved forward.

4.12.2. Buttons

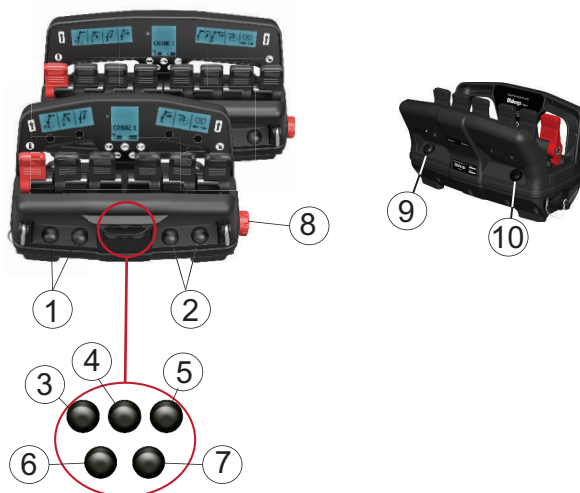

(1)-(2)	ON/OFF buttons [option] The controller has four configurable pushbuttons for controlling on/off functions e.g. start/stop engine, increase/decrease rpm on the engine etc. The function of each button is depending on the configuration of the specific crane.	Micro mode Push to choose micro mode. Push again to choose normal mode.	(7)
(3)	Menu CRANE Push to choose menu CRANE.	Stop button Push to deactivate the controller. Release to activate.	(8)
(4)	Menu EXTRA Push to choose menu EXTRA.	OLP release Push and hold to activate OLP release. See section "OLP release".	(9)

(5)	Menu ON-OFF Push to choose menu ON-OFF.	Manual extensions Push simultaneously to activate OLP for manual extensions.	(6)&(9)
(4)&(5)	Locking of controller See section “Locking and unlocking the controller”.	Error code display Push the button to display error codes in the system. If there are more than six error codes at the same time, the six most recent ones sent from the control system, are shown.	(10)
(6)	Horn Push to sound the horn.		

Locking the controller

1. Push and hold button (4) and (5) while the emergency stop button is pushed.
2. Keep button (4) and (5) pushed while pulling out the stop button. The centre display then shows a large locked padlock symbol 

Unlocking the controller

1. Push and hold button (4) and (5) while the emergency stop button is pushed.
2. Keep button (4) and (5) pushed while pulling out the stop button.
3. Release button (4) and (5).

The controller is ready to use.



4.12.3. Menus, standard functions and symbols

The function of each lever may be the same or different in different menus. The left and right displays show which function is controlled by each lever. The function symbols show a direction (up, down, left, right) which applies to when the lever is moved forwards.

Main menus:

- CRANE menu, button (3)
- EXTRA menu, button (4)
- ON-OFF menu, button (5)



In each of the main menus the operator can step through submenus by pushing the menu button repeatedly.

Each function is operated using a specific lever. If a lever is faulty or moved at startup, the lever and the function is disabled. The other levers work as normal. With the 2 extra levers on the 8 lever controller, it is possible to use the seventh and eighth functions simultaneously with functions 1-6, without shifting CRANE menu.

**CRANE menu, button (3)**

When the operator pulls out the stop button on the controller, it always starts in CRANE 1 menu. The submenus in CRANE menu are configured in production but can be changed by Hiab service personnel.

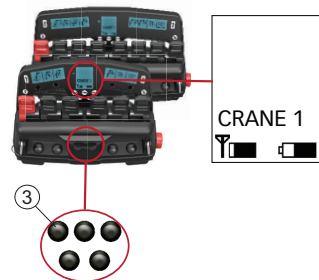

Example of submenus for the 6 lever controller:

"CRANE MENU"	Left side display			Centre display	Right side display		
					CRANE 3 		
				CRANE 2 			
				CRANE 1 			

Example of submenus for the 8 lever controller:

"CRANE MENU"	Left side display				Centre display	Right side display			
						CRANE 2 			
					CRANE 1 				

EXTRA menu, button (4)

The EXTRA menu contains hydraulically proportional functions for example front and rear stabiliser extensions and legs, boat supports, bunk shifting, etc

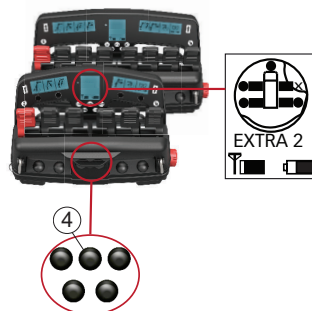

Symbols shown on the displays

The order of the levers is customized.

- Crane stabiliser leg (1) down/up.
- Crane stabiliser leg (2) down/up.
- Auxiliary stabiliser leg (3) down/up.
- Auxiliary stabiliser leg (4) down/up.
- Crane stabiliser extension (5) out/in.
- Crane stabiliser extension (6) out/in.
- Auxiliary stabiliser extension (7) out/in.
- Auxiliary stabiliser extension (8) out/in.

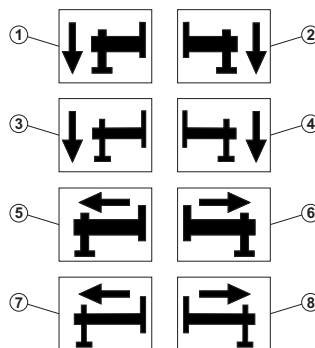

ON-OFF menu, button (5)

The ON-OFF menu includes functions such as engine start, stop and throttle. The functions are shown as text instead of symbols in the displays. A lever may be moved in any direction in order to activate the corresponding function.

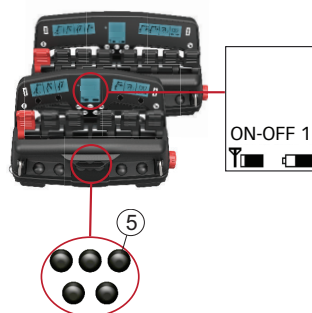

Examples of the left side display		Centre display	Examples of the right side display	
FRONT LIGHT	REAR LIGHT	ON-OFF 2 	PUMP 1	PUMP 2
ENGINE START	ENGINE STOP	ON-OFF 1 	ENGINE RPM UP	ENGINE RPM DOWN

4.12.4. Battery and battery charger

Battery

The voltage level of a fully charged battery is approximately 8,4V and it provides about 5-8 hours working time. Note that the battery voltage remains between 7,6V and 7,5V for a long time. Therefore, the battery voltage cannot be used to estimate remaining hours of use.

Install a fully-charged battery in the controller as shown on the right. It is important to fit the battery the right way round. If the battery is upside-down the controller will not start.



Battery charger

The battery charger is to be fitted in a protected environment, preferably in the cab. Two batteries are delivered with each unit, one of which can always be placed in the charger.

Normal charging time for a flat battery, is approximately 3 hours. Operating ambient temp: Battery = 0° to + 45°C.

Display A

- (1) lights when the charger is activated.
- (1) and (2) lights during charging.
- (1) and (3) lights when the battery is fully charged.

Display B

- Shows the battery voltage (8.4).
- When the display blinks 0.0 there is error in the battery: Change battery.

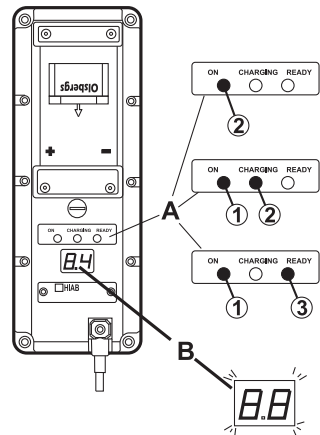

**NOTE**

A charged battery is a concentrated energy source. Never store a charged battery in a toolbox or similar, where there is a risk of a short due to metal components. Used batteries should be taken care of according to the local regulations.

5. Starting crane operation

5.1. Starting operations [AR+]

- **General case:**

Place the vehicle on a flat, firm and stable surface. The vehicle inclination (α) during crane operation must **not be more than 3°**. If this value is exceeded, unintentional crane movements can occur.

To determine the inclination of the truck, check the spirit level on the crane. When the bubble is in the middle of the gauge, the crane is in horizontal position. When the bubble is between the two circles, the crane inclination is between 0° and 5°.

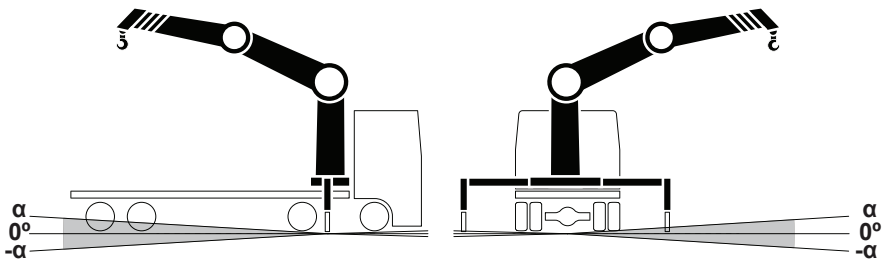
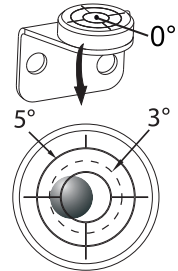

- **Working with boom system beyond 60°**

To avoid side deflection and in order to guarantee the safest operation when working with e.g. Lifting Accessories and/or Hoist applications, the vehicle has to be completely levelled in any direction ($\alpha=0^\circ$).

- **Particular case 1: Working with extra load on the vehicle platform to benefit from VSL+.**

To avoid sudden movements of the vehicle and damages on the stabiliser system, the vehicle must be completely levelled in any direction ($\alpha=0^\circ$).

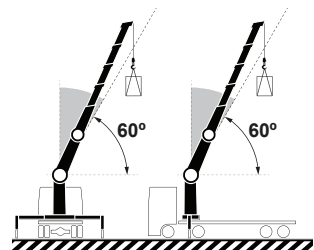

NOTE

- Operating the crane in to and out of transport position must also be done with the vehicle completely levelled.
- Activate the parking brake and place chocks under the wheels to prevent vehicle movement.

Engage the PTO

Engage the PTO (Power Take Off) and bring the vehicle engine to the correct rpm.



NOTE

- Rpm too high: the oil in the hydraulic system might overheat.
- Rpm too low: during crane operation, the vehicle engine could stall.
- The maximum rpm may depend upon a governor on your PTO combination.



CAUTION

Close the driver's cab to prevent access to unauthorised persons.

Start the control system

The operating levers must be in neutral position before start up. To start the control system, push the On/Off button  on the User Interface.

The LED above the button lights up. The system will check itself for a few seconds. The warning lamps on the stabiliser legs light up.

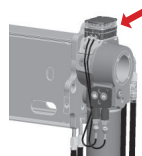
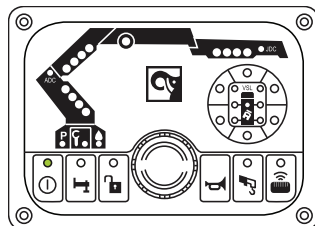

Start the controller

1. Fasten the controller to a waist belt, or shoulder-neck strap, in the most comfortable operating position. The stop button should be on the right-hand side.
2. Push button  on the User Interface. The LED above that button will blink.
3. To activate the controller, pull out the emergency stop button by turning it clockwise. The LED above the remote button becomes steady and the warning lamps on the stabiliser legs blink.

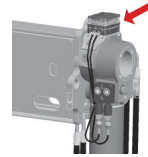
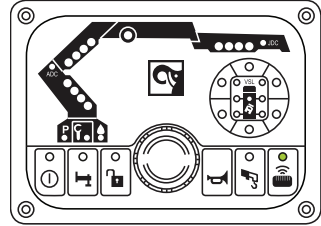

Indications XSDrive

The first LED in the LEDs menu starts blinking. When communication has been established, the LED will give a steady light = ready for use.



Indications CombiDrive

“Wait” is shown on the centre display while radio contact is being established. On the decoder LED (1) is lit. LED (2) starts to blink.

When contact has been established CRANE 1 menu and signal strength are displayed on the controller. On the decoder LED (2) on gives a steady light and LED (1) flickers.



5.2. Set the stabiliser system

To ensure the maximum stability of the vehicle, all the stabiliser extensions and legs must be fully extended and set to the ground without lifting the wheels from the ground.

- **Cranes with VSL:** when the stabiliser extensions are not fully extended, the lifting capacity is optimized by the VSL feature to ensure the maximum stability of the vehicle.
- **Cranes without VSL:** crane must be operated with the stabiliser extensions fully extended and the stabiliser legs set to the ground without lifting the wheels from the ground, otherwise the stability of the vehicle will not be ensured.

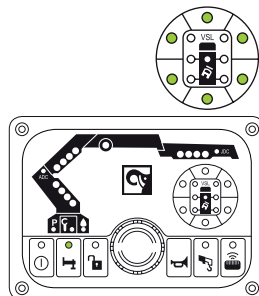

DANGER

For cranes without VSL the operator is the responsible to make sure that the vehicle is stable while lifting a load and the maximum load is not exceeded.



WARNING

If your vehicle has a front auxiliary stabiliser system, with one or two legs, make sure that all legs are correctly set to the ground before you start operating the crane.

Stability sector indication

The operator must have a full view of the stabiliser system when operating it. To confirm a full view of the stabiliser system, button  is pushed on the User Interface on the side where the stabiliser system is going to be operated. As soon as the button has been pushed, the LED for the active stabiliser leg will light green.

- **Cranes with VSL:** the stability sector LEDs will indicate the crane capacity in six different sectors due to stability. The stability sector indication will change according to the stabiliser system position.
- **Cranes without VSL:** the stability sector LEDs will light green regardless of the situation. The operator is the responsible to make sure that the vehicle is stable while lifting a load.

5.2.1. Stabiliser system and ground conditions

Always:

- Make sure that the ground can support the load that the stabiliser leg imposes on the ground. (*)
- Make sure that the ground is not undermined.
- Use the extra support plates that are large and firm enough for your crane model.

The maximum permitted ground inclination under the stabiliser leg plate is 5°.

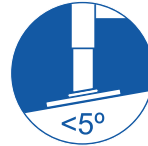
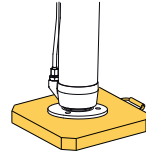

(*) The maximum load (P) that the stabiliser leg can apply to the ground is (kN):

Crane Model		Stabiliser leg config.			
		Short	Medium	Long	Extra long
265-285		200	200	-	-
395-425-505-335K-410K-435K		230	230	-	-
322-377-328-352-362-388		230	200	180	-
422-477	Medium stab. exten.	220	220	-	-
	Long stab. exten.	240	240	-	-
	Extra long stab. exten.	220	220	-	-
358-398-408-418		230	200	180	-
528-548-558-638-658		-	250	250	-
858-1058		370	370	370	370
HIAB Auxiliary stabilisers		180			



NOTE

Sign that shows the maximum force that the stabiliser legs can apply to the ground.





**DANGER**

Check that the extra support plates do not bend or sink into the ground.



Do not lower the stabiliser legs on the edge of an embankment, soft ground, hollows, etc... Lower the stabiliser legs only on to a flat, firm and stable surface.

5.2.2. Activate the stabiliser system

Manually controlled stabiliser system:

1. Make sure manual control is active. If not, push the button  on the User Interface
2. Push the button  to activate stabiliser system operation.

Remote controlled stabiliser system:

1. Make sure remote control is active. If not, push the button  on the User Interface.
2. Select the menu for stabiliser system on the controller/joystick.
3. On the side where the stabiliser extensions are to be operated outwards, push the button  to activate stabiliser system operation and confirm the view. The stabiliser legs can be driven up and down regardless of the side.

**NOTE**

Confirm the view on both sides of the crane on the User Interface installed on the high seat [option].

5.2.3. Extend the stabiliser extensions

The procedure of setting the stabiliser extensions differs depending on the type of stabiliser extensions. Repeat the instructions for the stabiliser extension on the other side of the vehicle. For auxiliary stabiliser system [option]: Repeat the process.

Hydraulically controlled stabiliser extensions

Unlock the stabiliser locking device (1) (if fitted) and extend the stabiliser extensions with the levers on the valve or the controller depending on your crane configuration.

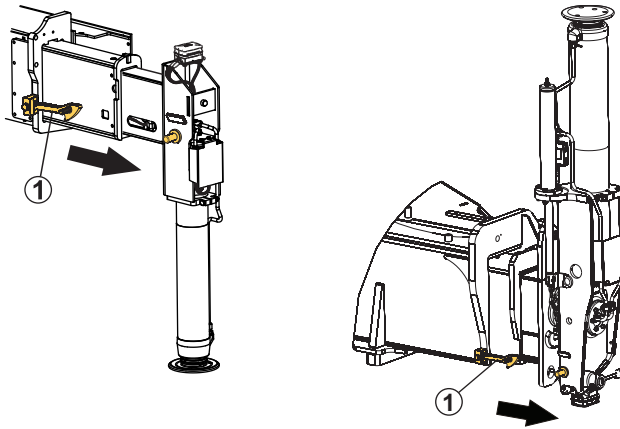

DANGER

Do not stand in front of the hydraulically operated stabiliser extensions when you are operating them!

5.2.4. Set the stabiliser legs [AR+]

The procedure of setting the stabiliser system differs depending on the type of stabiliser system. Repeat the instructions for the stabiliser extension and leg on the other side of the vehicle. For auxiliary stabiliser system [option]: Repeat the process.



WARNING

Take care not to lower the stabiliser leg onto your foot.



**NOTE**

For cranes with VSL the stabiliser leg downward movement is automatically stopped at a pre-given force level. To exceed this pre-given force level, operate the stabiliser leg down once again.

**DANGER**

Always ensure that the stabiliser legs and stabiliser extensions are in working position and securely locked.

Never operate up any stabiliser leg if you have load on the crane.

Put the extra support plates

- Put the extra support plates under the stabiliser leg plates (if necessary).

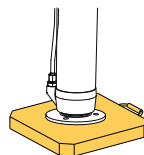
**DANGER**

Do a check that the support plates do not bend or sink into the ground!

Non-tiltable stabiliser legs

1. Make sure that the stabiliser extensions are extended.
2. Put the extra support plate (1) onto the ground (if necessary).
3. Operate the stabiliser leg downwards until it is set to the ground.

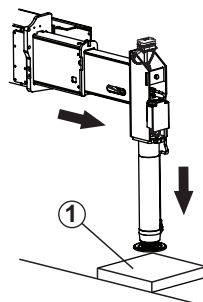
**Hydraulically controlled tiltable stabiliser legs [AR+]****DANGER**

Do not stand in the tilting area. Make sure the tilting mechanism remains unlocked during the complete tilting.

1. Make sure the stabiliser extension is extended a little and the stabiliser leg can be rotated freely of the vehicle.
2. Tilt the stabiliser leg:
Pull out the locking pin (1) and turn the lever (2) 180°. Operate the stabiliser leg lever until the stabiliser leg has turned 180°.
3. Turn the lever (2) -180° and check that the locking pin (1) is automatically locked.
4. Extend the stabiliser extension.
5. Position the extra support plate (if delivered) onto the ground.
6. Set the stabiliser leg to the ground.

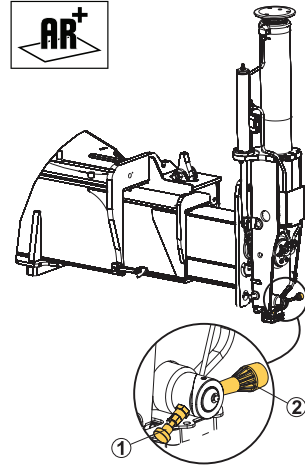

WARNING

Always check that the stabiliser legs and the stabiliser extensions are in correct position and tilting mechanism is locked in working position.

5.3. Operate the boom system out of transport position



WARNING

- A crane with add-on equipment can differ from the operations described in this section. For this reason, study the operating instructions for any add-on equipment carefully.
- Always ensure that the stabiliser extensions and legs are in working position and securely locked before operating the boom system out of parking position.



DANGER

Always operate a manually controlled crane from the position shown in the image!

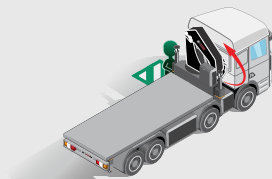

1. If the stabiliser system is manually controlled, push button  on the User Interface to activate remote control.

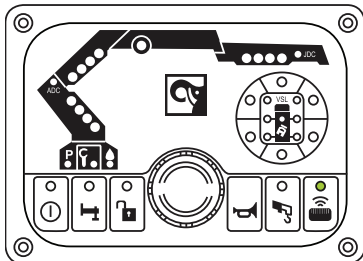

- If using remote control, push button (1) on the controller to change the menu into crane operation.

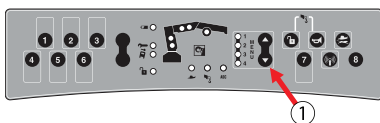
NOTE

As soon as you have selected remote control operation, it is no longer possible to operate the main control valve levers.

Operate the boom system

- Raise the first boom.
- Slew the crane to the working position.
- Extend the 1st boom hydraulic extensions.
- Extend the 2nd boom hydraulic extensions. The crane is now ready for use.

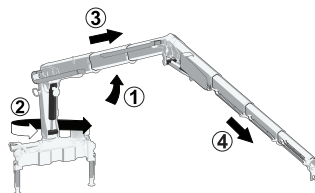
NOTE

As soon as you have selected remote control operation, it is impossible to operate the main control valve levers.

6. During operation

6.1. Features

The control system provides a large number of features. Certain features are standard, others are options.

6.1.1. Controlling the crane speed with the controller XSDrive

At startup, the system by default is set to full speed. To reduce the speed, push button  once. The low speed LED will light continuously. By pushing the button again, the crane returns to full speed and the LED goes out.

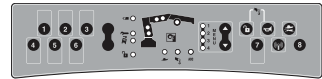

When pushing the speed selector button, all levers must be in neutral.



NOTE

The crane speed will depend upon the crane functions you are using and how many crane functions you operate at the same time.

6.1.2. Controlling the crane speed with the controller CombiDrive

At startup the crane speed is set to 100%. It is possible to choose between three different speeds. Push button (7) to change. Current speed is shown as a percentage on the display.



6.1.3. Supervision of spools

If a valve spool movement is greater than the equivalent lever or joystick movement on the controller, a safety feature is tripped, and all crane movements stop.

This occurs if a control lever on the valve is moved while the remote control is engaged.

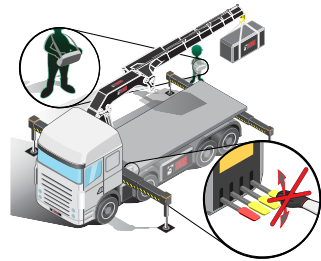

6.1.4. APO Automatic power off

APO is a feature which automatically switches off the power to the control system. It consists of:

1. Timeout controlled power off. (30 minutes by default).
2. Parking brake controlled power off.

Through the vehicle's parking brake, APO offers a safety feature which ensures that the control system is off when the vehicle is moving. When parking brake is released, the control system receives a signal and shuts OFF.

For emergency operation

During 5 seconds, it is possible to activate the control system by pushing the ON/OFF button on the User Interface.

6.1.5. ADO Automatic Dumping of Oil

If a lever is not moved for 3 seconds, this feature diverts the oil to the tank, thereby preventing the oil from overheating. The next lever movement stops the dumping and it functions as normal.

6.1.6. ASC Automatic Speed Control

The ASC feature automatically provides the extra power by reducing the speed smoothly, when working close to the rated capacity. When the load decreases, normal speed is restored.

6.1.7. ADC Automatic Duty Control

The purpose of the ADC feature is to increase the lifting capacity by 10%.

The first boom pressure sensors indicate if there is a positive or negative pressure on the first boom.

Normal capacity

- If the first boom is pressed down, the sensors indicate a negative pressure and the lifting capacity is normal during the complete lifting cycle.

Increased capacity (ADC mode)

- ADC lamps light up.
If the sensors indicate a positive pressure, the lifting capacity is increased during the complete lifting cycle.

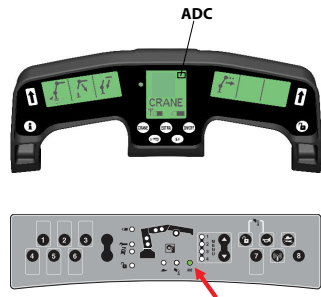
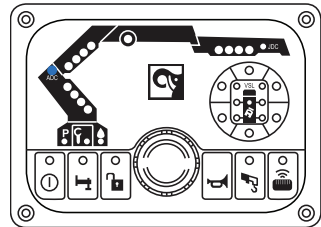

6.1.8. PFD Pump flow distribution

When operating several functions simultaneously the pump flow may not be sufficient. PFD will now take over, reducing the speed of all operated functions. Uncontrolled movements are thus avoided, smooth simultaneous operation is achieved.

6.1.9. Slewing sector [option]

Within slewing sector, lifting capacity can be reduced due to stability. The overload warning will be given at a lower load in the limited sector than outside the sector. In case of an overload warning you may slew out of the sector but not further into it.

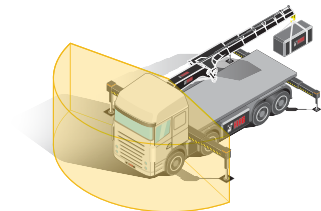

6.1.10. VSL Variable Stability Logic [option]

The VSL function detects the stabiliser extensions position and that the stabiliser legs are pressed to the ground. The benefit is that the crane lifting capacity is optimized in relation to vehicles stability.

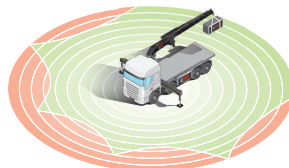

The VSL diagram

After the installation on the truck, the installer prints unique stability diagrams for each crane. In the diagrams, each colored curve shows the cranes stable area and the maximum working pressure in the 1st boom cylinder with stabiliser extensions in different outreach. The more you extend your stabiliser extensions the more stability and crane's capacity you will get.

The diagram shows 9 different sectors surrounding the crane and in each sector there is a percentage shown. A percentage of 90 indicates that the available working pressure is reduced to 90% in this sector.

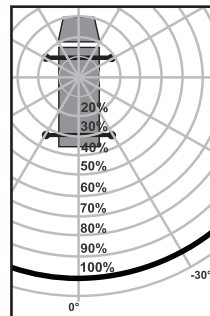

Examples of stability diagrams:

Stability diagram (One on/off sensor on stabiliser extensions)

With one On-Off sensor, you see two curves and two positions of the stabiliser extensions:



Not fully extended 0-99% (shown as 0%)



Fully extended (100%)

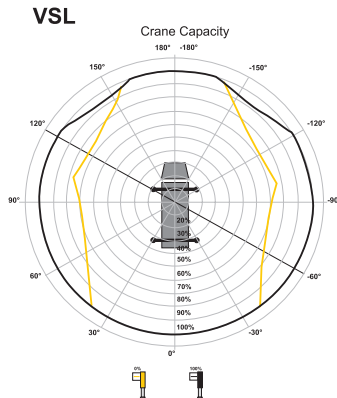

Stability diagram (Two on/off sensor on stabiliser extensions)

With two On-Off sensors, you see three curves and three positions of the stabiliser extensions

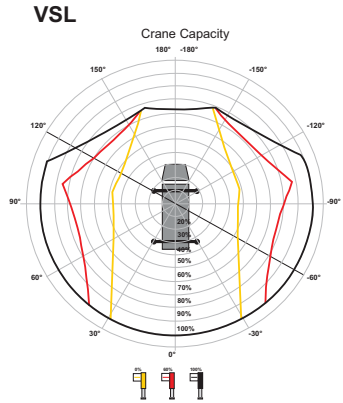
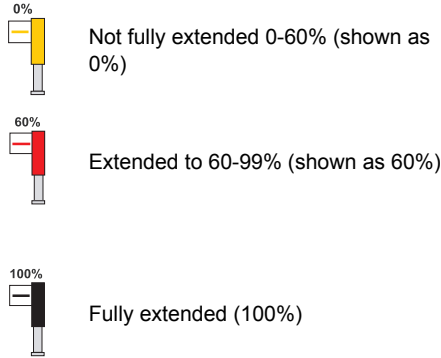

Stability diagram (Variable analogue sensor(s) on stabiliser extensions)

With variable sensors any position can be read. You see five curves and five positions of the stabiliser extensions.

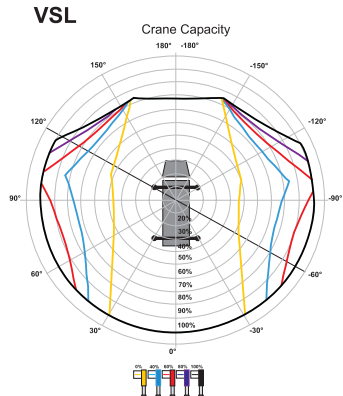
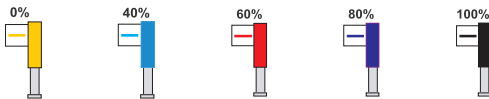

NOTE

For cranes with JIB, you will have an additional diagram.

The Lifting Capacity Diagram:

The software creates six different capacity diagrams with the stabiliser extensions in different positions (represented in the truck drawing). For cranes with JIB, another six capacity diagrams will be automatically generated.

The software calculates three loads:

- **CURVE A:** Maximum load at maximum outreach (1).
- **CURVE B:** Intermediate load between curve A and C.
- **CURVE C:** Maximum momentum curve (2).

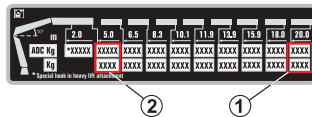

The three coloured curves represent the three different loads. These loads are represented by the position of the crane in each sector (degrees) and also by the outreach of the boom extensions (meters or feet and inches).

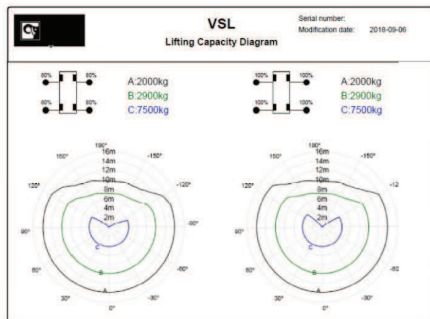
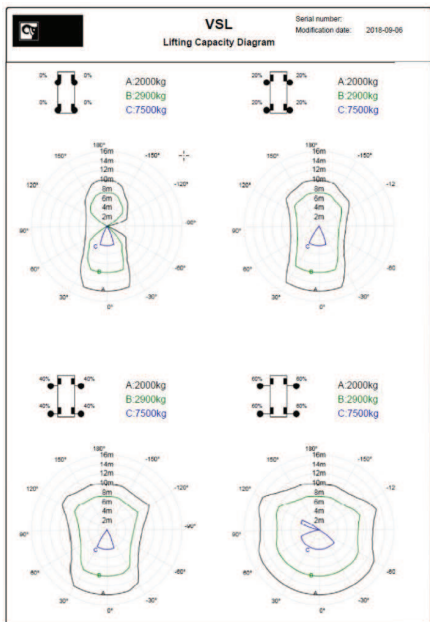

NOTE

Speak to your Hiab authorised service workshop to request these diagrams for other loads.

6.1.11. VSL+ (Variable Stability Logic Plus) [option]

VSL+ is a patented feature that automatically optimises the crane's capacity in relation to the vehicles stability.

VSL+ works like VSL but has the capability to take advantage if the vehicle platform is loaded, the extra load acts as a counter weight.

This automatic feature increases flexibility, especially on worksites where it is not possible to utilize the full stabiliser extension reach.



**WARNING**

In order to get the maximum benefit from the VSL+ system, some of the wheels of the vehicle shall be lifted from the ground but Hiab strongly recommends that at least one wheel is braked by the parking brake and has contact with the ground.

When using the crane in MEWP mode (Mobile Elevating Working Platform mode), VSL+ is automatically disabled.

The percentage on the main display shows the capacity gained due to the feature VSL+.



6.1.12. LSS-V Load stabilising system-vertical [Option]

LSS-V reduces vertical oscillations in the boom system. This feature makes it easier to handle loads at long outreach.



WARNING

Deactivate LSS-V when working in confined spaces. Compensating movement can cause the crane to collide with obstacles.

If LSS-V is active when SPACE is switched off, it will be active when SPACE is started again.

Activate and deactivate LSS-V (By default) with the controller XSDrive

Push button (6) to activate and button (8) to deactivate.

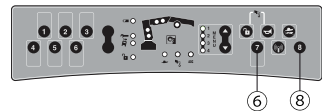

Activate and deactivate LSS-V (By default) with the controller CombiDrive

1. Push the ON-OFF button (5) on the remote control.
 - CombiDrive with 6 levers: Menu 2 ON-OFF
 - CombiDrive with 8 levers: Menu 1 ON-OFF
2. Move the levers according to the text in the display.
 - CombiDrive with 6 levers: lever 4 (activate) and lever 5 (deactivate).
 - CombiDrive with 8 levers: lever 7 (activate) and lever 8 (deactivate).

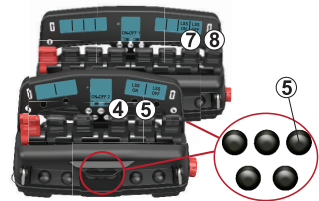

6.2. OLP (Overload protection)

OLP is a safety function that prevents overloading of the crane. With 90% of maximum permitted pressure the warning lamps on the stabiliser legs double blink. When 100% of maximum pressure is reached the warning lamps will blink.

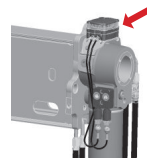

OLP boom system

When 100% of the maximum permitted pressure is reached, OLP cuts in and stops all functions that increase the pressure.

The pressure level in the first and second boom is indicated by the LEDs on the user interface:

- 50% of maximum pressure – 1 of 4 LEDs light green
- 70% of maximum pressure – 2 of 4 LEDs light green
- 90% of maximum pressure – 3 of 4 LEDs flash red
- 100% of maximum pressure – 4 of 4 LEDs flash red

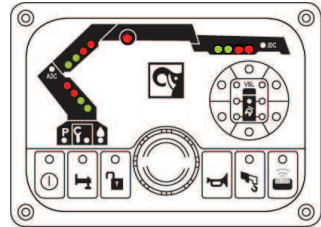

NOTE

Do not operate heavy loads with the extensions fully retracted. In an OLP situation it is an advantage to be able to retract the extensions.

OLP stabiliser system [option]

If a stabiliser leg is overloaded, slewing is stopped in the direction towards the stabiliser leg where the OLP occurs. The crane stops. The warning lamps on the stabiliser legs will blink. On the user interface the LED for the overloaded stabiliser leg will light red. Move the levers to neutral and only operate permitted (pressure reducing) functions.

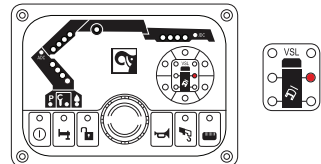

VSL - OLP [option]

VSL-OLP occurs when there is a risk of instability of the vehicle. Slewing is stopped towards the instability direction and the crane stops. On the user interface the LED for VSL-OLP and the LEDs for the 1st boom will light red. Move the levers to neutral and only operate permitted (pressure reducing) functions.

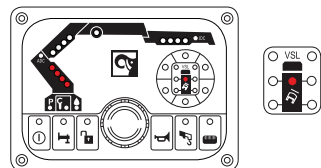

OLP manual control

If one prohibited function is used, all functions will stop. The crane will be fully operational as long as only allowed functions are used.

6.3. OLP - indications on the controller

XSDrive

OLP boom system: The cylinder LEDs indicate a percentage of maximum pressure:

- 70% of maximum pressure reached - lower LED on each cylinder light green
- 90% of maximum pressure reached - lower LED on each cylinder flash red
- 100% of maximum pressure reached - both LEDs on each cylinder light red

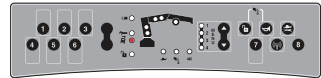
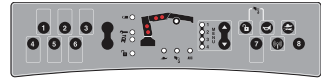

OLP stabiliser system [option]: No indication on the controller. See indications on the User Interface.

VSL-OLP [option]: The LED for VSL light red.

CombiDrive

OLP boom system shown on the left and right displays:

- A percentage of maximum permitted pressure in the cylinders is shown on the displays. When 50% or more of maximum pressure is reached, the percentage alternates with the function symbol once a second in the display corresponding to each lever. The display shows 50%, 70%, 90% and 100% as the pressure increase.
- When pressure reaches 100 %, all functions that would increase pressure are blocked. If the operator attempts to operate a blocked function, the function symbol is replaced by a cross while the lever is engaged. When the lever is returned to neutral position, the cross disappears and the function symbol returns. Operate permitted (pressure reducing) functions only. In an OLP situation, symbol "x" is shown in every menu in the centre display.

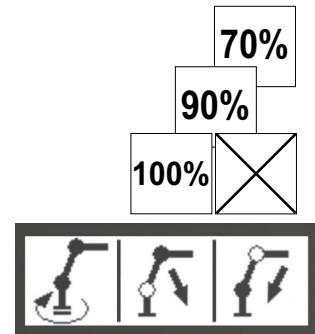
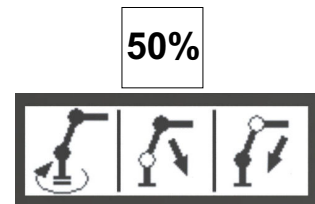

OLP stabiliser system [option]:

The centre display shows the symbol 100% and the symbol for which stabiliser leg has overload (marked with an X).

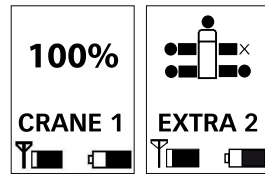

Symbols shown on the display:

- (1) Stabiliser extension in or not completely out. Stabiliser leg set (the stabiliser leg reaches the minimum pressure to the ground).
- (2) Stabiliser extension out. Stabiliser leg not set.
- (3) Stabiliser extension out. Stabiliser leg set.
- (4) Stabiliser extension out. Stabiliser leg in OLP situation.
- (5) Front left or right stabiliser leg in OLP situation.

In an OLP situation, symbol "x" is shown in every menu in the centre display.

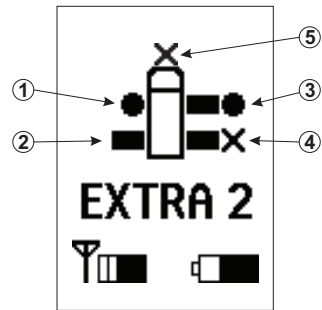

VSL-OLP [option]:

The centre display shows the symbol VSL. The 100% symbol in the left display alternates with OLP for crane. Move the levers to neutral and only operate permitted (pressure reducing) functions.

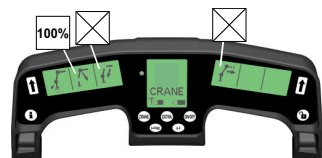
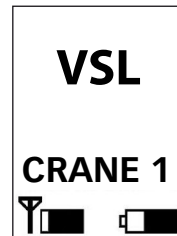

6.4. To release OLP

If all functions have been blocked due to OLP it is possible to temporarily release OLP and operate an appropriate crane function to correct the overload situation. OLP release is active in 5 second intervals. After each 5 second interval of OLP release there is a wait before the release operation can be activated again. The wait will increase in three steps: 30, 60 and maximum 90 seconds. During each 5 second interval only one function at a time can be operated. Extension out cannot be operated at all. The 5 second interval starts to count down as you move the lever.

**DANGER**

Only use the OLP release to get the crane out of a locked position. Never use the OLP release to overload the crane deliberately!

**NOTE**

In case of a crane breakdown, the use of OLP release will be part of the investigation. If the use of OLP release is too excessive it might affect warranty.

OLP release on User Interface

Push and hold button  to temporarily release OLP and operate an appropriate crane function to correct the overload situation. The cylinder pressure LEDs on the User Interface perform a running light. The LED for padlock symbol will blink red.

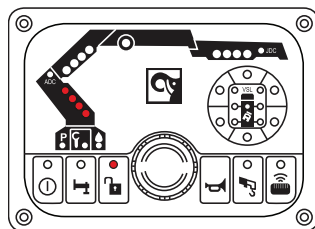
**OLP release on controller XSDrive**

Push and hold the button  on the controller whilst operating load reducing functions. On the User Interface the cylinder pressure LEDs perform a running light. The LED for padlock symbol will blink red.

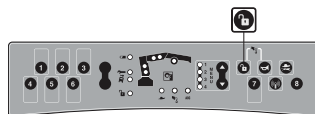
**OLP release on controller CombiDrive**

Push and hold the button (9) on the right hand side below the display handle. The unlocked padlock will appear in the centre display. On the User Interface the cylinder pressure LEDs perform a running light. The LED for padlock symbol will blink red.



7. Ending crane operation

7.1. Operate the boom system into transport position



WARNING

- A crane with add-on equipment can differ from the operations described in this section.
- For this reason, study the operating instructions for any add-on equipment carefully.



DANGER

- During folding of the boom system, always operate the crane manually from the position indicated in the figure.
- With remote controlled cranes, stay in a safety area while the boom system is moving.



7.1.1. Operate the boom system

1. Slew the crane until the crane is parallel to the vehicle.
2. Retract the 2nd boom hydraulic extensions completely.
3. Retract the 1st boom hydraulic extensions completely.
4. Lower the boom system against the vehicle. (Do not extend the second boom cylinder fully).

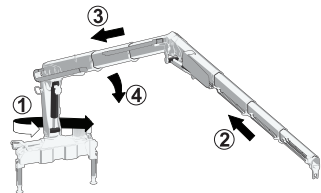

7.2. Placing the stabiliser system in the transport position [AR+]



DANGER

Do not stand in the stabiliser legs, tilting area.



WARNING

Do not put your foot on the support plate.

Risk of crushing injuries.

Always keep hands away from moving parts during operation.



The procedure of operating the stabiliser legs differs depending on the type of stabiliser leg. Repeat the instructions for the stabiliser extension and leg on the other side of the vehicle. For auxiliary stabiliser system [option]: Repeat the process.





DANGER

Always ensure that the stabiliser legs and the stabiliser extensions are in transport position and securely locked before moving the vehicle.

- **Manually controlled crane:**

Activate stabiliser system operation on the User Interface by pressing button .

- **Remote controlled crane:**

- Manually controlled stabiliser system: Press button  on the User Interface to deactivate the controller. Activate stabiliser system operation on the User Interface by pressing button .
- Remote controlled stabiliser system: Select on the controller the defined menu for the stabiliser system operation.

Non-tiltable stabiliser legs

1. If there is an extra support plate (1) for the leg delivered, retract the stabiliser leg a little, if not, go to step 3.
2. Remove the extra support plate (1).
3. Retract the stabiliser leg completely.
4. Retract the stabiliser extension completely.

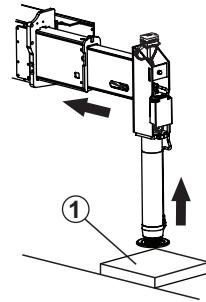

WARNING

Risk of crushing injuries.

Always keep hands away from moving parts during operation.

Hydraulically controlled tiltable stabiliser legs [AR+]



DANGER

Do not stand in the tilting area. Make sure the leg remains unlocked during the complete tilting.

1. If there is an extra support plate for the leg delivered, retract the stabiliser leg a little, if not, go to step 3.
2. Remove the extra support plate.
3. Pull out the locking pin (1) and turn the lever (2) 180°.
4. Operate the stabiliser leg lever. The stabiliser leg will now rotate automatically to vertical position.
5. Turn the lever (2) -180° and check that the locking pin (1) is in and the lever (2) cannot rotate.
6. Retract the stabiliser leg completely.
7. Retract the stabiliser extension completely.

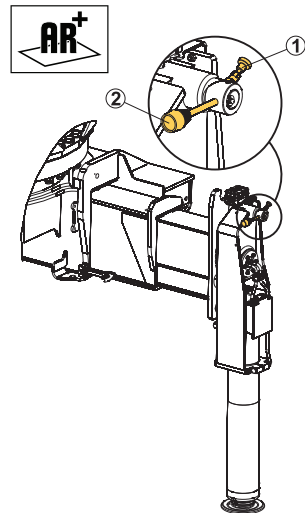

**WARNING**

Risk of crushing injuries.

Always keep hands away from moving parts during operation.

Retract the stabiliser extensions

The procedure of retracting the stabiliser extensions differs depending on the type of stabiliser extensions. Repeat the instructions for the stabiliser extension on the other side of the vehicle. For auxiliary stabiliser system [option]: Repeat the process.

Hydraulically controlled stabiliser extensions**DANGER**

Before you retract the stabiliser extensions:

- Make sure that you can see them clearly during their operation.
- Be prepared to reduce the speed of the operation to prevent accidents.
- Make sure that the stabiliser legs are fully up and locked.

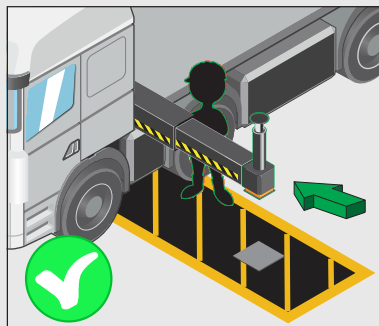
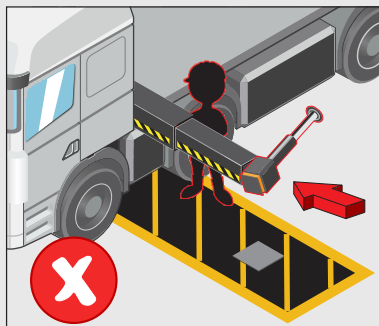

Retract the stabiliser extensions with the levers on the valve or the controller depending on your crane configuration. Make sure that the stabiliser locking device (1) (if fitted) is securely locked.

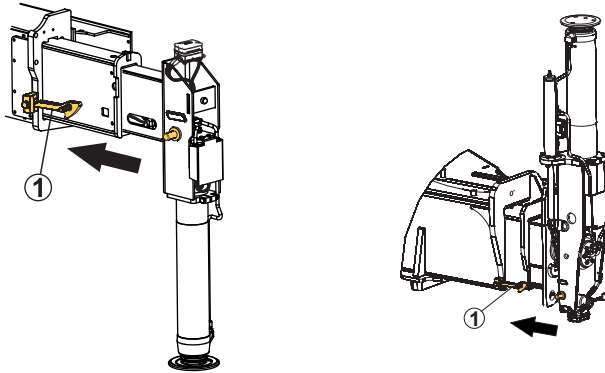

7.3. Switching off the control system

- Switch off the control system with the on/off button .

If you are using the remote controller:

- Push the stop button on the controller and switch off the control system.
- Disengage the PTO.

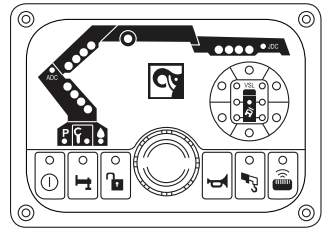

7.4. Emergency operation Valve-V200

EMERGENCY operation to bring the crane to transport position

Do like this:

On the main control valve:**DANGER**

To operate the crane like this is **HIGHLY DANGEROUS** because during emergency operation all crane security is disconnected.

Always go to/contact a Hiab authorised service workshop when the seal wire has been broken.

1. Engage the pump.
2. Break the security sealing on dump valve 1 (1) on the main control valve.
3. Use a screw driver (or similar) and push the knob on dump valve 1 (1).
4. Check that no unintended movements starts. If you get unintended movements then release the knob and contact Hiab service.
5. Push the dump valve button and turn 90 degrees until it is blocked.
6. Operate the crane to transport position using the levers on the main control valve.

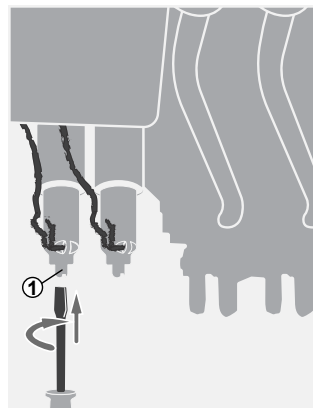

Separate stabiliser control valve: [option]



DANGER

To operate the crane like this is **HIGHLY DANGEROUS** because during emergency operation all crane security is disconnected.

Always go to/contact a Hiab authorised service workshop when the seal wire has been broken.

1. Follow actions 1-5 in previous section "*EMERGENCY operation to bring the crane to transport position*". *The button on dump valve 1 on the main control valve is to remain depressed.*
2. Break the security sealing on dump valve 2 (2) on the main control valve.
3. Use a screw driver (or similar) and push the knob on dump valve 2 (2).
4. Check that no unintended movements starts. If you get unintended movements then release the knob and contact Hiab service.
5. Push the dump valve button and turn 90 degrees until it is blocked.
6. Operate the stabiliser extensions and stabiliser legs to transport position using the levers on the stabiliser control valve.

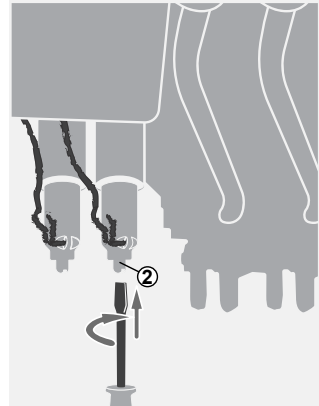

7.5. Transport warning [option]



WARNING

If you switch off the safety system when stabiliser extensions/stabiliser legs are not locked in the transport position, and/or if the first boom angle exceeds a certain specified angle, the indicator LEDs on the UI for both the cylinders and the hoist will flash red for a while.



The vehicle must not be moved.

- A warning, visible and audible from the driving position for transport, indicates when the crane height exceeds a predetermined maximum and when the stabiliser extensions/stabiliser legs are not locked in the transport position.
- The audible warning can be silenced by an acknowledgement button [option] or by a signal indicating that the parking brake of the vehicle is engaged.



The vehicle must not be moved

1. Switch the system on, put the crane into the transport position.
2. Switch off the system. The vehicle may be moved.

**DANGER**

After use always put the crane into the transport position! When you have to park the boom on the load space, or over the load, secure the boom and the lifting accessories to prevent any unintentional movement of the crane and the lifting accessories.

8. Maintenance and Service

8.1. Service

No welding/drilling work on the crane



DANGER

- Do not do any welding work on the crane. Welding work on the crane may only be carried out by a Hiab authorised service workshop, or in close consultation with Hiab.
- Do not drill into the crane yourself. Drilling work on the crane may only be carried out by a Hiab authorised service workshop, or in close consultation with Hiab.
- Never try to reinstall the crane. Only a Hiab Installer may reinstall the crane.



Leakages



DANGER

- STAY AWAY from oil leaks in the hydraulic system! Oil in the hydraulic system is under high pressure, can spill, be very hot and cause you injury.
- Do not replace any hydraulic hoses or lines yourself.

You can disconnect a hydraulic line or a hose only for specific operator's tasks (for example, disconnecting the JIB or other accessories).

1. Make sure that the cylinders are not at the end of stroke and minimise as much as possible the forces acting on them.
2. Switch off the system.
3. Disengage the PTO.
4. Make sure that you wear the correct personal protective equipment.
5. Move all levers in both directions to the end of the stroke to release all the pressure in the line.
6. Slowly loosen all connectors.
7. If they do not come out easily, you have remaining pressure in the line. Stop and do step 5 again.

Deal with an oil leak as follows:

1. Rest the crane on the floor or on the truck platform.
2. Switch off the control system.
3. Disengage the PTO.

Leaking coupling:

- a. Tighten the coupling with a spanner.
- b. If tightening does not help, contact a Hiab authorised service workshop.

Small leak on a line or hose:

- a. Determine if you can still park the crane.
- b. If you can, park the crane and go to a Hiab authorised service workshop.
- c. If you cannot, contact a Hiab authorised service workshop.

8.2. Warranty

Hiab only provides a warranty if:

- The "Warranty – Terms and Conditions" specified in the "Service & Warranty Manual" are fulfilled.
- The crane is inspected and maintained, by a Hiab authorised service workshop as specified in the "Service & Warranty Manual".
- Original HIAB parts are used for every repair or maintenance work.
- All security seal wires on the valves are still intact.

Always use original HIAB parts.

8.3. Follow the maintenance instructions!

Take the crane to a Hiab authorised service workshop for inspection and maintenance. Maintain lifting accessories according to the supplier's instructions.

**WARNING**

- Make sure that faults in the crane are corrected immediately!
- Never correct faults yourself that may only be corrected by a Hiab authorised service workshop.
- Carry out yourself only the service and maintenance work you have the requisite knowledge and experience for. Maintenance must be performed by qualified personnel.
- Always use personal protection devices and other safety means during the maintenance work in compliance with the regulations of the country in which you use the crane.
- All personnel must understand and comply with all warning and instructional decals attached to the body, crane and truck controls.
- Mark out the working area and make sure that there are no unauthorised persons inside.
- NEVER walk or stand under a crane or a suspended part. People may suffer fatal crushing injuries!
- When working on any part of the crane, put the "Out of Service" tags displayed clearly and wherever possible on the vehicle, and remove the ignition keys to prevent accidental operation.



NOTE

- Make sure that you have read the complete manual before starting the preventive maintenance. It provides detailed information about the maintenance process.
- Make sure that the manual and other documentation are in good condition, near the machine and available for anyone who needs it.

Maintenance intervals:

- Carried out by the **operator: daily and monthly inspection.**
- Carried out by Hiab or a Hiab authorised service workshop:
 - **1st service:** to be made after 50 hours of use.
 - **Regular service:** to be made when one of these conditions are met:
 - 1,000 hours of use
 - 10,000 cycles
 - 365 days



NOTE

The service indicator on SPACE (if present) will light up for the 1st and regular service.



NOTE

Refer to the "Service and warranty manual" to know the actions performed by the Hiab authorised service workshop.

Long storage of the crane

If you need to store your crane for a month or longer, do this first:

1. Clean it according to the instructions in the section "Cleaning" of this manual.
2. Lubricate it according to the lubrication schedule of this manual.
3. Put the crane into transport position and disconnect the power from the vehicle battery.
4. Put grease on the exposed piston rod(s) and the external seals of the hydraulic cylinders.
5. Put a plastic cover on the crane.
6. Protect it from rain, sun and dirt as much as possible.

Cleaning

Clean your crane and accessories regularly, but:

- Always set the power off before you start.
- Do not use aggressive cleaning agents.
- If you use a high pressure water jet, make sure that:
 - Maximum temperature of the cleaning water is 60°C.
 - Maximum working pressure is 150 bar.
 - Minimum distance between the nozzle and the surface to clean is 80 cm.

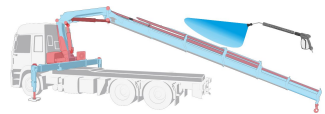

**CAUTION**

Never use a high pressure water jet on electronic parts, plastic components, signs, bearings, control valves, cylinders or the oil tank. Only the cranes surface may be cleaned with a high-pressure jet cleaner.

**NOTE**

Always lubricate after cleaning the crane.

**WARNING**

Keep the devices to go into the control station (handles, supports, platforms...) clean from oil, grease and dirt to prevent slipping and falling.

8.3.1. Daily inspection

Refer to the daily inspection checklist at the end of this manual to photocopy.

Presence of signs and symbols

- See chapter "Safety precautions and warnings" under section "Signs on the crane". Make sure that all the signs shown in section "Signs on the crane" are in position and in good conditions .
- Make sure that all the symbols on your crane are in good conditions.

Locking devices

- Make sure that the locking devices are undamaged and working properly.
- Make sure that the locking devices are properly locked.

Spirit Level

- Make sure that the spirit level is clearly visible to the operator and works correctly.

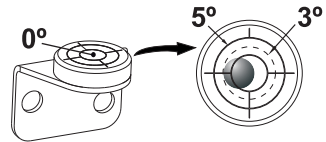

Shafts, shaft lockings, bearings and bushings

- Check that the shafts, shaft locking, bearings and bushings are undamaged and working properly.

Stop buttons

- Check that the Stop buttons are undamaged and working properly.

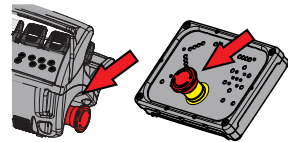

Levers

- Check that the levers operate smoothly.
- Check that the levers return to neutral position.

Controller

- Do a check of the controller functionality.

Crane structure

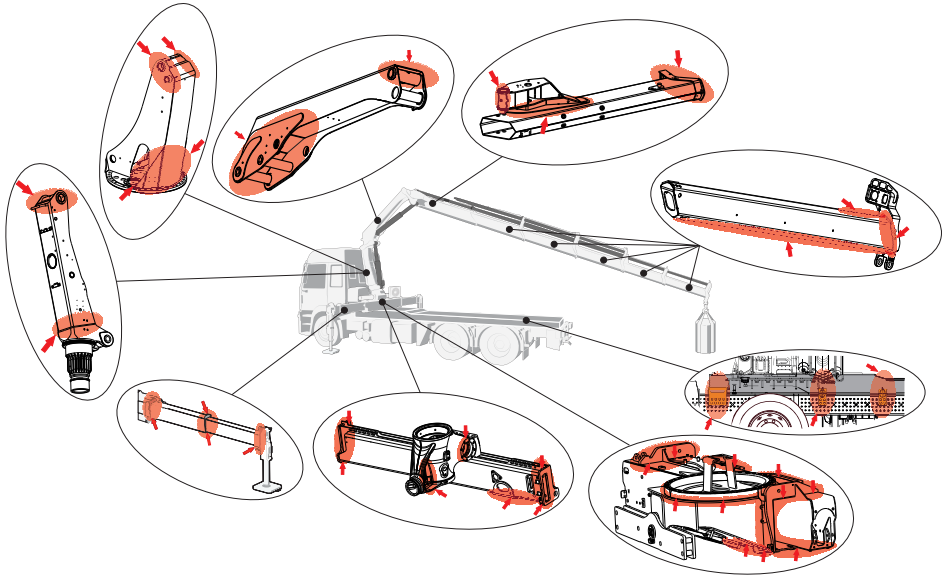

- Check for damage to the crane structure (e.g. any formation of cracks).



DANGER

In the event of damage that presents a safety risk:

- Do not use the crane.
- Have the damage repaired immediately by a Hiab authorised service workshop.

Hooks

Always keep the hook clean. Use a cloth to wipe away any dirt.

Before every working shift:

- Do an inspection of the general conditions of the Hook (1) for deformation (stretched, cracked, twisted, excessive wear...) and surface damages with significant depth (such as from chemicals or heat).
- Do an inspection of the Clevis/Link Shaft (3) for damage/deformation.
- Do an inspection of the two Spring/Roll pins (8) and (9) that are in place and properly retaining the central hook nut (6).

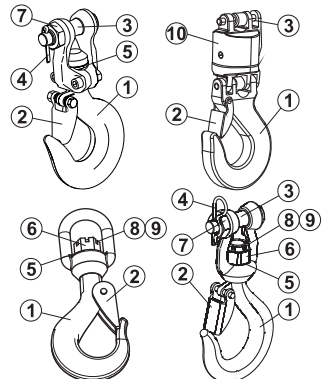

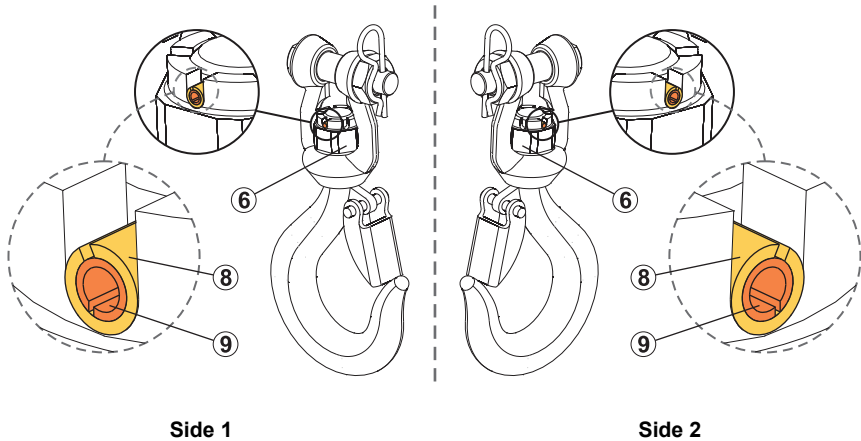

The two Spring/Roll pins (8) and (9) should be in place and nearly flush with the outer edge of the hook nut (6) on both sides. (See the pictures **Side 1** and **Side 2**).

- Do an inspection of the spring-loaded safety Latch (2). The Latch must close the entire throat opening.
- Do an inspection of the Clevis/Link Shaft (3), Clevis/Links Shaft nut (7) and Cotter/Safety pin (4) are in place.
- Do an inspection of the Plane bearing/Washer (5) or the Swivel (10) that is in good conditions.
- Do a general inspection for deformation and operation of the remaining items: clevis, swivels, washers, nuts, pins...
- Lubricate the hook according to the chapter "Lubrication of the hooks".



DANGER

In the event of damage or worn to prevent a safety risk:

- Do not use the hook.
- Have the damage repaired immediately by a Hiab authorised service workshop.

Add-on equipment and separate accessories (hoist, JIB, etc.)

- Check the cables, cable connections, the cable guides and the attachment points for the add-on equipment.
- Check the rope, rope connections, the rope guides and the attachment points for the add-on equipment.
- Maintain all add-on equipment, separate accessories, auxiliary equipment etc. according to the instructions supplied with it.
- Polyamid parts as well as all bolt components have to be checked and must be replaced in case of wear and tear.

Electronic components

- Check that these are in good condition.
- Make sure that the horn works correctly.

- Do a check of the LEDs on the User Interface.

LED Test on the UI box:

1. Push the ON/OFF button for at least 2 seconds.
The test is activated and all the red LEDs are illuminated. If the system is equipped with warning lights / lamp poles, all the lights will come on.
2. Release the button. After 3 sec, all the green LEDs are illuminated. The test is finished when all LEDs are off.

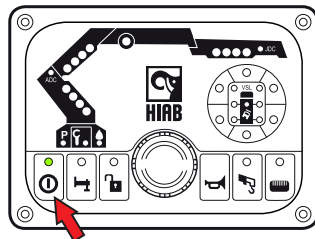

Hydraulic system and oil level in the tank

- Check that there are no leaks from the hydraulic hoses, lines and connections.
- Make sure that all security seal wires (Ex. LHV, dump valves, etc...) are not broken. Always go to/contact a Hiab authorised service workshop when the seal wire has been broken.

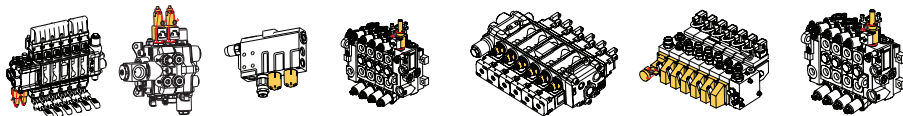

- Check oil level in the tank. If necessary, fill to correct level.



NOTE

Always place the vehicle on level ground with the crane in transport position while checking the oil.

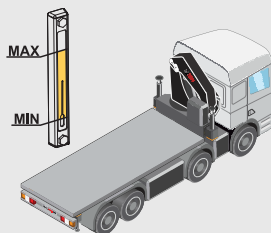

Oil level on the slewing housing

- Do a check of the oil level in the slewing housing. If necessary, fill to correct level.

Filters

- Check the filter indicator. If red, a workshop must replace the cartridge.

8.3.2. Monthly inspection and maintenance



NOTE

Refer to the monthly inspection checklist at the end of this manual to photocopy.

In addition to the daily inspection, carry out the following tasks each month:

Piston rods

- In cases where the cylinder piston rod is exposed to pollution due to the parking location, the chromed surfaces must be cleaned and oiled to prevent corrosion. This needs to be done regularly.

Pivot pins and bushes

- Inspect all the pivot pins and bushings for the crane boom and cylinders for damage, play, etc.

Bolts and screw fixings

- Check that bolt and screw fixings are tight. If not, contact a Hiab authorised service workshop

Cables and sensors

- Check that cables and sensors are in good condition.

Lubrication schedule

- Carry out the lubrication according to the instructions.

Slewing bearing / upper column bearing

- Check that the slewing bearing / upper column bearing is lubricated sufficiently.

Hydraulic system

- Check that the hydraulic pump attachment screws are tightened.
- Check if the oil in the hydraulic system needs to be changed, or have it tested by a workshop or a specialist.

Add-on equipment etc.

- Maintain all add-on equipment, auxiliary equipment etc. according to the instructions supplied with it.

Connectivity [option]

- Verify that you see both the POWER LED (1) and the STATUS LED (2) with the steady green light in the gateway box in order to confirm that there is a successful connection to the network. Refer to the section "Gateway connection box".

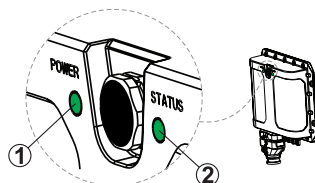

8.3.3. Annual maintenance

Take the crane, at least once a year, to a Hiab authorised service workshop for inspection and maintenance.

The workshop must carry out the following maintenance tasks at least once a year.

Hydraulic oil

- Change the hydraulic oil.



NOTE

If the workshop is equipped and the personnel prepared to do a test of the oil quality and think that the oil change is not needed, they can postpone it on their own responsibility.

Hydraulic system oil tank filler cap

- Change the filler cap.
- Replace filters.

Slewing housing

- Change oil in the slewing housing.

Hooks

- Replace missing or faulty parts on link assembly: shafts, safety pins and nuts.
- Replace the hook for a new one if the hook is damaged.
- Replace the latch assembly if it is damaged, missing or malfunctioning.
- **Hook 8 t and 10 t (without spring/roll pins):** replace the hook for a new one if the clevis/link or split clevis retaining nuts are missing or damaged.
- **Hook 10 t (with spring/roll pins):** replace the two spring/roll pins and the plane bearing for a new ones, at least once a year.

8.4. Lubrication

General greasing of the cranes

Incorrect or insufficient lubrication of a crane is the number one cause of premature failure.



WARNING

Before and after a long stop of the crane, lubrication is absolutely necessary. This is especially important after a winter shutdown.



WARNING

Follow the lubrication schedule exactly. If you do not do so, you can cause serious damage to the crane and to add-on equipment.

Procedure:

1. Shut down the crane.
2. Make sure that all the lubrication points are clean before lubricating. Dirt can damage the parts.
3. Lubricate all points in each section.
4. Operate the crane through the full cycle for each section. Moving the lubricated parts is really important to get the full and correct lubrication of all moving components.
5. Shut down the crane and repeat the lubrication.
6. Lubrication is finished when the grease spills out from the ends. Clean the excess grease.

**WARNING**

Personnel should never attempt to work on a crane that is moving. Serious injury or death will occur if you try to work on an activated/moving crane.

**CAUTION**

When you use pressure grease pumps, open the plastic safety guard of the nipple and close it at the end.

Greases

Use lithium-based grease containing EP additives (consistencies 2 and 3 are recommended, depending on the climate).

**CAUTION**

Do NOT grease with graphite or molybdenum-disulphide additives.



Recommended greases:

BP LS EP 2, ESSO UNIWAY EP2 N, AGIP GR MU/EP3, NYNÄS UNIFETT EP.

Alternative:

Use a Teflon grease spray to lubricate the extensions and mobile parts.

8.4.1. Lubrication schedule

	Lubricate after every 16 hours of use.
	Lubricate after every 50 hours of use.
	Grease after every 50 hours of use. A: Internal pads, B: Internal guides

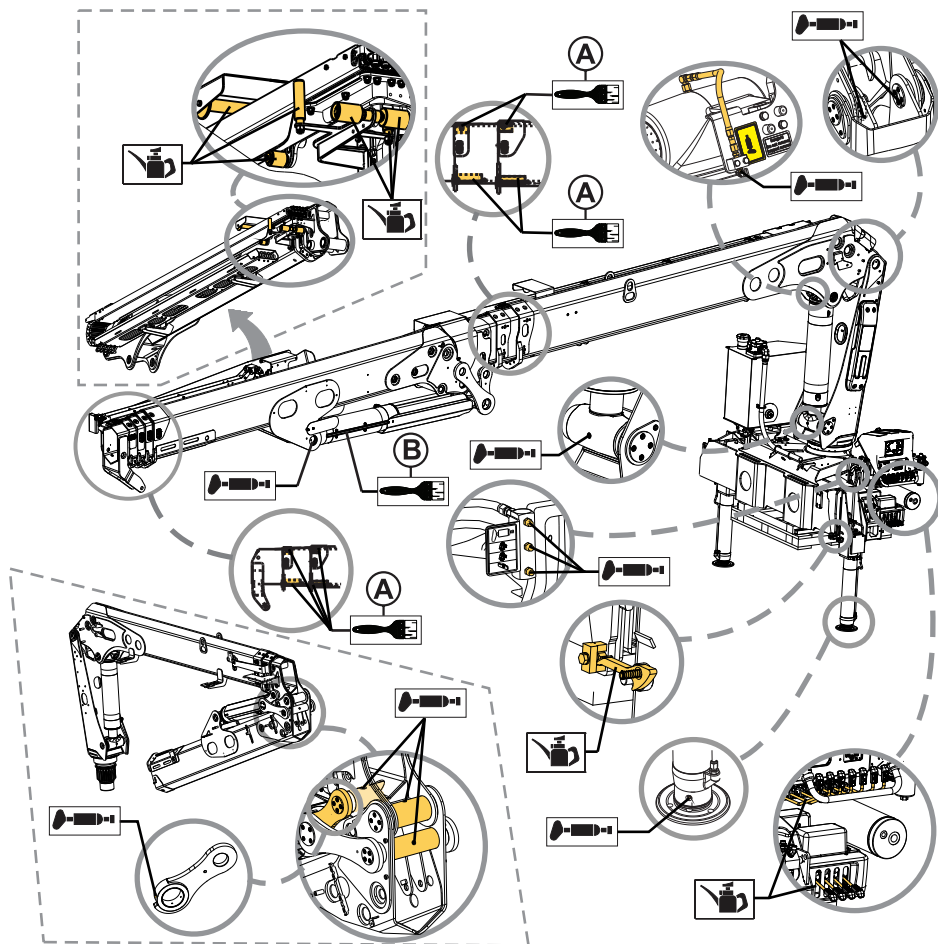

8.4.2. Greasing the upper column bearing and three-point bridge



DANGER

The upper column bearing must be greased while the crane is slewed.



NOTE

The lubrication points can be fitted differently than showed in the image.

Grease through the nipples in the greasing manifold, located on the crane base, according to the greasing signs. If the manifold does not exist, grease directly through the nipples, located on the upper column bearing.

If you are greasing the upper column bearing without help:

1. Grease the upper bearing with a little grease.
2. Slew the crane a little.
3. Grease it again and repeat until the column has completed one turn.

If you are greasing the upper column bearing with help:

One person greases the upper column bearing, while another carefully slews the crane.

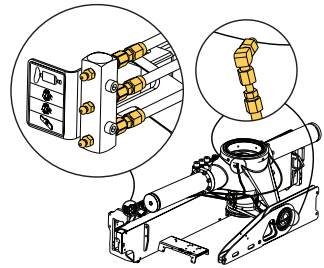

DANGER

Be very careful that the person greasing the bearing does not come into contact or get crushed by the crane!

Greases: Use lithium-based grease containing EP additives (consistencies 2 and 3 are recommended, depending on the climate).

Do not use grease with graphite or molybdenum-disulphide additives.

8.4.3. Lubrication of slide pads in boom system

Front upper slide pads

- Extend extensions with load in order to create enough clearance.
- Lubricate.

Front lower slide pads

- Extend extensions without load and push slightly against the ground in order to create enough clearance.
- Lubricate.

8.4.4. Lubrication of the hooks

Hooks with plane bearing

If the hook cannot rotate easily without load:

- Put grease on the plane bearing surfaces (1).
- Use a heavy duty penetrating spray grease, type "ZEP 2000" or equivalent quality.

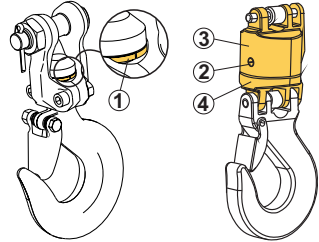

Hooks with swivel

Put grease if the swivel cannot rotate easily:

1. Remove the screw (2) and mount a grease nipple.
 2. Add grease until grease appears between house (3) and shank (4).
 3. Mount the screw (2).
- Use a bearing grease, type "Texaco Multifak EP 2" or equivalent quality.

8.5. Checking and topping up oil levels

8.5.1. Slewing housing: checking the oil level and topping up

Recommended oils for topping up oil in the slewing housing

Use a hypoid oil, type API GL-5, SAE J2360 (Formerly MIL-L-2105), viscosity SAE-80W-90, cleanliness NAS 1638:8. For example: "ENI ROTRA MP 80W-90", "SHELL SPIRAX S2 A 80W/90" or equivalent quality.



CAUTION

The oil used for filling must be clean. Do not mix different oils (a mixture will change the oil properties).

Oil level checking

Measuring stick or level glass

- Check if the oil level on the measuring stick (1) or on the level glass (2) is between the maximum and minimum levels.

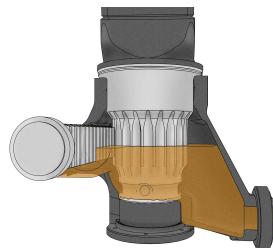

Oil filling procedure (top up procedure)

Measuring stick or level glass

1. If the oil level is below the minimum level, remove the measuring stick/plug (1).
2. Top up through the filling hole (1) with hypoid gear oil.
3. Make sure that the oil level is between the maximum and minimum levels on the measuring stick (1) or on the level glass (2).

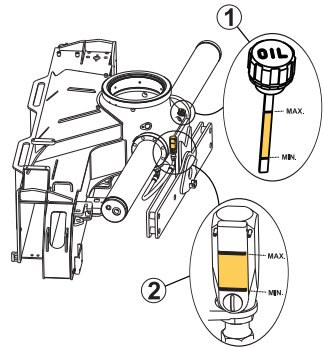

8.5.2. Checking of the oil level of the tank

1. Place the crane and stabiliser legs in the transport position.
2. Place the vehicle on level ground.
3. Check the oil level in the tank.
4. If the oil level is too low, top up with hydraulic oil.

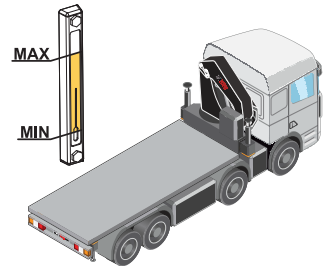

Oil filling / Top up

1. Make sure that the required equipment to fill the tank is fully clean.
2. Put the crane in the parked position.
3. Clean the area around the oil filler cap.
4. Fill with oil up to the max level indicator.

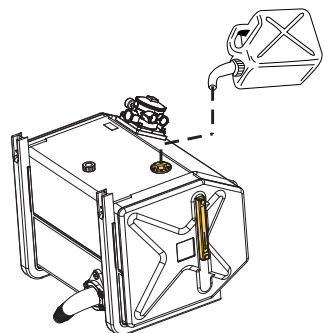

CAUTION

- Never fill the tank completely, because during operation, the volume of the oil could expand as the temperature increases.
- Never use recycled oil!

Filling the oil tank with hydraulic oil



CAUTION

The oil used for filling must be clean. Do not mix different oils (a mixture will change the oil properties).

Hydraulic oils must have been dealt with according to cleanliness requirements ISO 4406: -/16/13.



Hydraulic oil that is approved for HIAB products must comply with one of the following standards or equivalents:

- ISO 11158 HV
- DIN 51524 part 3 HVLP
- ISO 6743/4 L-HV

Verify with the supplier that the quality and performance of the hydraulic oil complies with the previous standards.

When changing from mineral oil to a non-polluting synthetic oil, or when changing to biodegradable oil, contact a Hiab authorised service workshop.

Recommended hydraulic oils

	ISO VG 32	ISO VG 46	ISO VG 68
Examples	Tellus S2 V32 Super 32 Hydrol L-HV 32	Shell TELLUS T 46 Texaco RANDO HDZ46 Agip ARNICA 46	Mobil SHC 526
Where to use them			

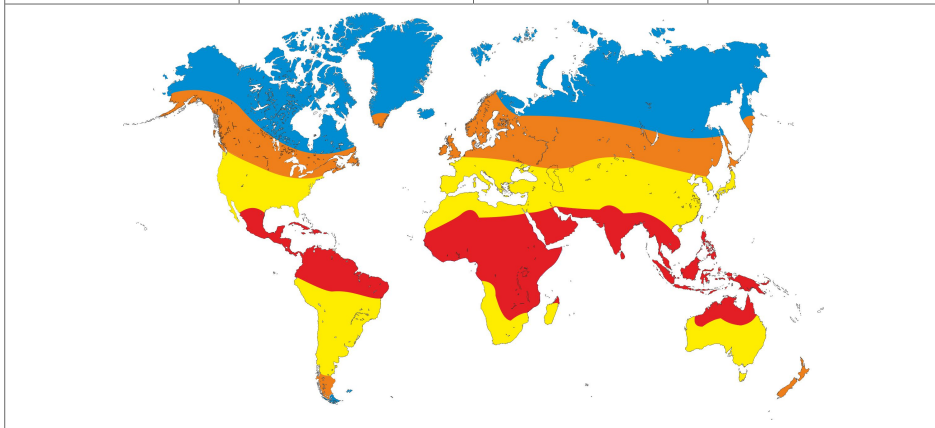

Viscosity of oil

The viscosity of the oil is of great importance to achieve high efficiency of the hydraulic system.

The naming of the oil in the table below: 32, 46 or 68 tells the viscosity of that oil at 40°C (reference temperature).

Viscosity of oil at 40°C	Temperature range
32	-25°C to 75°C
46	-15°C to 90°C
68	-5°C to 90°C

The recommended viscosity during normal working conditions is between 16 and 40cSt.

Hiab strongly recommends an oil working temperature below 70°C. If necessary consider an oil cooler or heater.



NOTE

If you need to work at a temperature below -25, contact a Hiab authorised service workshop.

Environmentally friendly oil

The environmentally friendly oils recommended for HIAB products are ester based synthetic hydraulic fluids (synthetic ester).



CAUTION

Vegetable oils do not meet Hiab requirements and must not be used.

After filling the tank

1. Operate each crane function to its end positions.
2. Operate the crane to parked position.
3. Check and top up the oil tank to max level on the tank gauge.
4. Bleed the air from the hydraulic system.

8.6. Replacement of filters

Filter cartridges must be replaced by a Hiab authorised service workshop:

- After the first 50 hours operation
- Then after every 1000 hours operation
- Or at least once a year.

How do you verify if the filter needs a replacement?

The high pressure filter is on the crane base, connected to the pressure line from the pump. It has an indicator (1) that turns red when the replacement is needed.

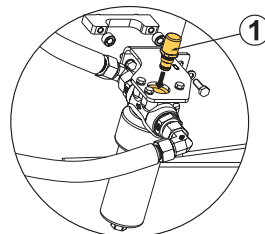

The return oil filter is on the oil tank, and can have a clogging indicator. This indicator turns red when needed. In all other cases (if the filter time is expired or without clogging indicator), you must follow the general recommendations for its replacement.

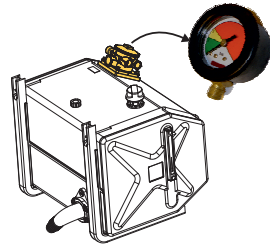

There are other filters on your crane (the pressure-reducer filter (1) on remote-controlled cranes, and the breathing filter (2) on the oil tank). These filters have no indicator and you must follow the general recommendations for their replacement.

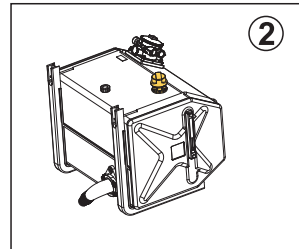
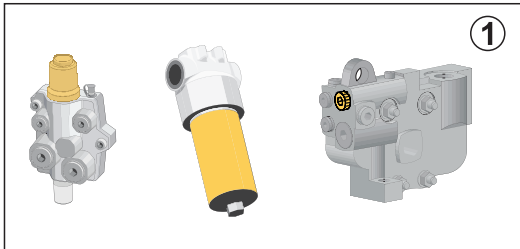

8.7. Bleeding air from the hydraulic system

Bleed the air from the hydraulic system:

- after changing the hydraulic oil
- after working on the hydraulic system
- if your crane works slowly or jerkily
- if your crane has not been used for a long time



WARNING

Air in the hydraulic system can lead to faults and damage

To bleed the air from the hydraulic system, proceed as follows:

1. Slowly extend and retract each stabiliser extension to its end position at least two times.
2. Slowly extend and retract each stabiliser leg to its end position at least two times.
3. Set stabiliser system in working position and operate the crane out of parked position.
4. Slew the crane slowly.
 - If your crane has a rack-and-pinion slewing system, slew the crane in each direction to the slewing stop at least twice.
 - If your crane has a continuous slewing system, slew at least two complete rotations.
5. Slowly raise and lower the 1st and the 2nd boom to its end position at least twice.
6. If the crane is equipped with JIB, slowly raise and lower the JIB at least twice with main boom system pointing downwards and upwards.

7. Slowly extend and retract the boom extensions to their end position at least twice.
 - a. If your crane is equipped with JIB, extend and retract the 2nd boom extensions with the JIB pointing almost vertically upwards and downwards.
 - b. Slowly extend and retract the JIB extensions to their end position at least twice.
8. Slowly operate each hydraulically operated add-on equipment such as hoist, grapple, pallet fork, etc. to their end position at least two times.

**CAUTION**

Do not keep the lever engaged at the end position of each movement.

9. Check the oil level in the tank and top up if necessary.

8.8. Troubleshooting

8.8.1. Main fuses

If the microprocessor detects a fault, this must be rectified immediately.

Fault	Probable cause	Action
<p>The control system does not work at all.</p> <p>The indicator light next to On/Off button on the User Interface is not lit, even if you push On/Off.</p>	Defective fuses.	<ol style="list-style-type: none"> 1. Replace faulty fuses in the: <ul style="list-style-type: none"> - vehicle - standard box - relay box (See Description, Components, Fuse, Location) 2. Check all the cable connections.

Description	Components	Fuse	Location
System main fuse	Relay Box, Standard Box, Oil Cooler	40 A	Located on the vehicle where the crane is mounted.
Fuse for all components controlled by the relay box.	Hydraulic main control valve, stabiliser leg warning lamp, Remote control, User Interface, MUX box. Truck warning interface, Work lights.	15 A	Located inside the relay box (1).
Fuse for all components connected to the standard box.	Hydraulic main control valve, stabiliser leg warning lamp, User Interface, MUX box. Truck warning interface.	10 A	Located inside the standard box (2).

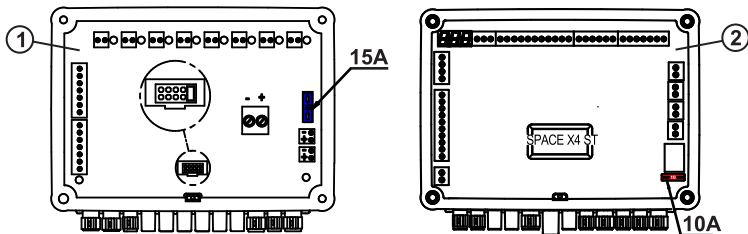

Main fuses CD

Description	Components	Fuse	Location
Fuse for all components controlled by the radio decoder	DA-26	10 A	Located inside the radio decoder (3).
Fuse for DA-26	Remote controlled valves	2x10A	Located inside the DA-26 (4).

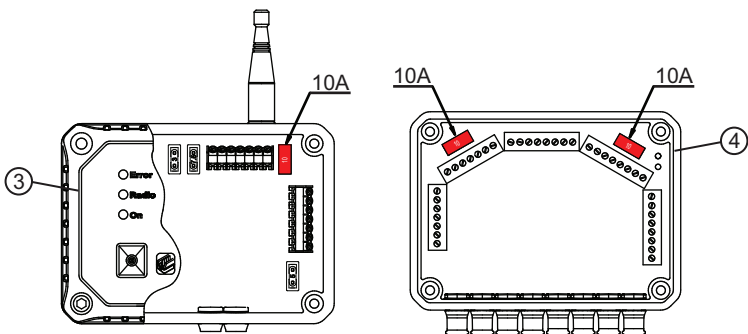

8.8.2. Faults on the crane

Faults in the crane must be rectified immediately.



DANGER

- Only correct yourself the faults that according to the table you may rectify.
- Follow the instructions exactly!
- All other faults must be corrected by personnel in a Hiab authorised service workshop!

Fault	Probable cause	Action
Electronic system will not start.	Parking brake on the truck is not engaged.	Engage parking brake on the truck.

Fault	Probable cause	Action
The hydraulic pump makes a noise. Warning! Stop using the crane immediately!	Oil tank filler breather is clogged.	Clear the blockage or replace the entire filler cap.
	Oil level in the tank is too low.	Top up the oil tank and bleed the hydraulic system.
	Hydraulic pump is faulty.	Go to a Hiab authorised service workshop.
Leak on hydraulic system: leaking coupling, hose or line. Danger! Keep away from any oil leak.		1. Push in the Stop button [If fitted].
		2. Disengage the PTO.
		3. Contact a Hiab authorised service workshop.
Stabiliser extensions do not slide out.	Stabiliser extensions are still locked.	Unlock the stabiliser extensions.
	Hydraulic fault.	Go to a Hiab authorised service workshop.
The stabiliser extensions do not slide out/in. (Chain-driven stabiliser system)	Incorrect chain tension.	Contact a Hiab authorised service workshop.
The stabiliser leg cylinder cannot keep the truck load and it goes inwards.	Check valve damaged.	Go to a Hiab authorised service workshop.
	Cylinder internal leakage.	Go to a Hiab authorised service workshop.
	Soft ground surface.	Set again the stabiliser led onto the ground or add an extra support plate between the cylinder and ground.
Slewing support cylinders do not turn	Three-way valve failure.	Go to a Hiab authorised service workshop.
Irregular slewing movements and unusual noises in cranes with rack and pinion slewing system.	Insufficient oil in the hydraulic system.	Top up the oil tank.
	Insufficient oil in the slewing housing.	Top up the oil in the slewing housing to the required level.
	The upper slewing bearing is not properly lubricated.	Lubricate the bearing.

Fault	Probable cause	Action
	The bearings in the slewing housing are damaged.	Go to a Hiab authorised service workshop.
Irregular slewing movements and unusual noises in cranes with continuous slewing system.	Insufficient oil in the hydraulic system.	Top up the oil tank.
	Insufficient oil in the gear box.	Top up the oil in the gear box to the required level.
	Bearing assemblies and pinion are not properly lubricated.	Lubricate the bearing while slewing.
	Bearing assemblies or pinion are damaged.	Go to a Hiab authorised service workshop.
One function of the controller does not work.	One lever of the controller was not in neutral at start up.	1. Push in the Stop button.
		2. Make sure that all levers are in neutral.
		3. Release the Stop button.
Crane does not react to controls. Indicator lamps light up on the User Interface.	The crane is in an OLP situation.	Perform movements to reduce the load moment. If necessary, release OLP.
<p>Crane does not work properly:</p> <p>One or more crane functions do not work, or not properly.</p> <p>Lifting capacity is much less than normal. Operating speed is significantly reduced.</p> <p>The service lamp is lit.</p>	The system has detected a fault.	Contact a Hiab authorised service workshop.
Cane performance when operating it with the controller is unsatisfactory.	The pressure-reducer filter is clogged.	Replace the pressure-reducer filter.
Boom system cannot keep the load height, and it goes down by itself.	Load holding valves on the first boom or second boom damaged.	Go to a Hiab authorised service workshop.
	Cylinder internal leakage.	Go to a Hiab authorised service workshop.
Boom extension cylinders do not follow the sequence.	Cylinder internal leakage.	Go to a Hiab authorised service workshop.

Fault	Probable cause	Action
Boom extensions shake during extending/retracting function.	Cylinder internal leakage.	Go to a Hiab authorised service workshop.
	Sequence screw in cylinder head loose.	Tight the screw in the right position.
Boom extensions cannot keep the load height and they move out by themselves.	Extension load holding valve damaged.	Go to a Hiab authorised service workshop.
	Cylinder internal leakage.	Go to a Hiab authorised service workshop.
Add-on equipment does not work properly (rotator, hoist, etc.)	Connectors not properly connected.	Reconnect the add-on equipment, according to the instructions.
	Other defect.	Go to a Hiab authorised service workshop.

8.8.3. Display [option]

The display has three menu items: *Error codes*, *Timers & Counters* and *VSL*. These items are shown on the screen when the display is first engaged. To be able to select an item push the menu toggle button or the OK button. In the bottom left of the screen the name of the item currently highlighted is shown.

Buttons

- (1) Push to go back to main menu
- (2) Push to go back one step
- (3) Push to toggle between menu items
- (4) Push to select item



Menu items

Error codes

If item *Error codes* is selected and there are errors present in the system the screen will show a three-digit number for each fault in the system.

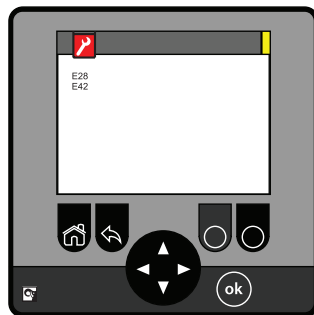

Timers & Counters

When item is selected information is shown about:

- Total time - Number of hours that the crane has been engaged
- Use time – Number of hours that dump valve has been active
- Lift count – Number of lifts made
- Time to service – Number of hours with the crane engaged until next service
- Use time to next service – Number of hours with dump valve active until next service
- Lifts to service – Number of lifts until next service



VSL

If you select this symbol, the truck VSL diagram shows six sectors surrounding the crane, and in each sector there is a percentage. A percentage of 90 indicates that the maximum pressure available in the 1st boom cylinder is reduced to 90% in this sector to guarantee full stability. The different sectors are marked with colors green, yellow, grey or red. The green indicates the highest percentage of the maximum pressure and red indicates the lowest percentage.

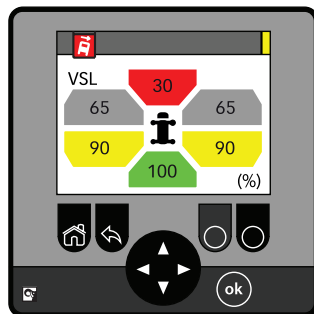

NOTE

The percentages refer to the maximum pressure available in each sector in the 1st boom cylinder, not the percentage of the maximum net load shown the load plate.



NOTE

Always refer to the stability diagram and the lifting capacity diagram delivered by the installer to know which are the lifting capacities and lifting loads that your crane has depending on the stabiliser legs and crane position.

Feature indication

If feature LSS-V is activated the screen turns blue and a symbol of a hook is shown. This to notify the operator of the occurrence. When the screen goes back to normal the symbol of the hook is shown in the top right of the screen. When deactivating LSS-V the screen turns blue again and the hook symbol is shown, this time crossed in a red circle. The hook symbol in the top right of the screen disappears.

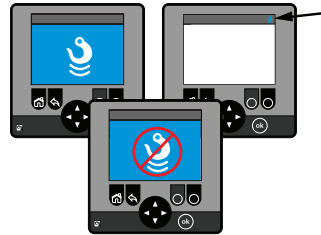

8.8.4. Error codes

SPACE has many error codes that can help you or Hiab technicians solve some problems with the system and/or a defective component. You can see the codes if you have the external display or a display on your controller.

If you have an error that is not in the following list, you must speak to your Hiab authorised service workshop.



TIP

If you have an error, try to restart the system one time, then verify that you still have the code on the screen before troubleshooting.

E003: Emergency stop

1. Set crane in manual mode.
2. Make sure that no emergency stop buttons are pushed on the crane or the controller.

E010: Lever not centred

Levers are not centred when the emergency stops are released. The error can be caused by lever not in neutral position or defective lever on the controller. If the operator operates a lever before the radio connection is established, the system will stop and the reset by pressing emergency stop is required.

1. Make sure that all the levers are in neutral positions and that spools can move freely in their valves.
2. Make sure that levers and the spools cannot be blocked.
3. Make sure that levers on the controller operate correctly.

E013: Service!

This error shows when one of the service counters (calendar days, hours, use time or number of lifts) has reached the limit (the error led lamp on the User Interface is on with a steady green colour).

- Go to a Hiab authorised service workshop.

E016: Remote battery empty

1. Recharge or change the battery in the controller.

E017: Controller

1. Push the emergency stop button and then release it. If you can still see the error, go to a Hiab authorised service workshop.

E056: JIB plug conflict

1. There is probably a short circuit inside the JIB plug. Clean the JIB cable connector and the JIB plug.
2. Put electric grease on both the connector and the JIB plug.
3. Set the system to OFF and then back to ON. If you can still see the error, go to a Hiab authorised service workshop.

E186: SAF

This error appears only when you move a lever for SAF.

SAF - Slew is in cabin sector

The SAF function cannot start because the crane is positioned in a specified sector where SAF is not available (for example: OLP sector, cabin sector, OPS sector, etc.). Change the crane position and activate SAF again.

SAF – Crane not in position

If the boom system is almost folded but the slew is not in the permitted area, the unfolding function cannot start. The solution is to fold the crane manually, and then the unfolding can be done with the SAF function.

E194: SAF

Refer to E186.

8.8.5. Gateway connection box [option]**POWER LED (1)**

The LED is steady green = the gateway has power.

The LED is off = the gateway has no power.

The LED is steady red = the gateway is in standby mode.

The LED shows a red blinking light = the gateway is shutting down.

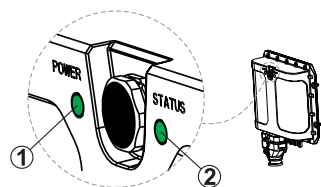
STATUS LED (2)

The LED is steady green = the gateway is operational and all connections are correct.





The LED shows a green blinking light = there is an error in the connection.

The LED is off = the gateway is off.

ERRORS

The STATUS LED (2) shows the status of the connection between the gateway, SPACE, GPS, and 3G/4G.

You can read different error codes from the STATUS LED on the gateway. If two or more errors exist in the system, the blinking sequence will show them in the same sequence.

Error code number	Blinking sequence	Problem	Possible cause
1	1 blink 	The gateway is not able to read the product data (this state is not in use in the factory image).	<ul style="list-style-type: none"> SPACE is not on. The cable between SPACE and the gateway is not connected correctly. The gateway is not configured correctly. Contact Hiab support.
2	2 blinks 	The gateway is not able to connect to the Cargotec cloud.	<ul style="list-style-type: none"> Poor 3G/4G coverage. The antenna is not connected correctly or it is damaged. The gateway is not configured correctly. Contact Hiab support.
3	3 blinks 	The gateway is not able to read the correct GPS location.	<ul style="list-style-type: none"> The antenna is not connected correctly. Poor GPS signal strength.
5	5 blinks 	The gateway is not operational yet.	<ul style="list-style-type: none"> Software is updating.



NOTE

If the system stops while the software is updating, the update will be put on hold until the system starts again.

Example: Several errors exist in the system.

Error 2 and 3 exist in the system.

**NOTE**

If error 1, 2, and 3 exist in the same time, do a check that you have the correct Gateway kit (**EU** for European Union or **US** for United States, Canada and Mexico).

9. Decommissioning

9.1. Decommissioning a crane



NOTE

Only qualified companies can remove the crane from the truck and dispose of it.

Cranes are designed and manufactured taking the environment into consideration. Environmental requirements and soundness have been considered when selecting the raw materials. The metal parts are designed to achieve a light and durable construction; this includes the selection of higher-quality grades of steel. When the crane is decommissioned at the end of its service life, years from now, waste will be created, which must be utilised and disposed of correctly. The crane must be decommissioned properly. Most of the crane's raw materials can be recycled.

Follow the regulations of the local authorities!

- Oil and grease must not be spilled on to the ground or released into the environment!
- Drain the oil from hydraulic cylinders, valves and hoses.

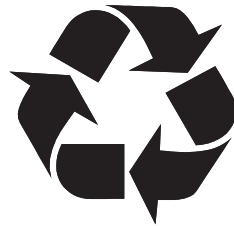

Sort the waste

- Deliver the metal parts for recycling, for reuse as raw material. These are load-bearing, structures manufactured from steel or cast iron, hydraulic cylinders and lines drained of oil, directional control valves, shafts, bearing bushes, control levers, small parts.

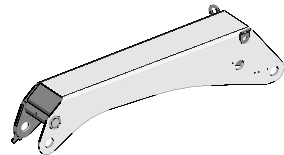

Energy waste can be utilised by incinerating it at a proper waste incineration plant.

- Spiral wraps, manufactured from polyethene, plastic, bearings (cleaned of lubricants) used in the column, beam system etc, manufactured from polyamide plastic.

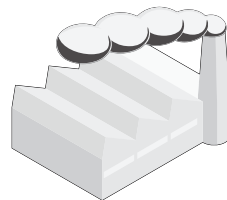

Unsorted waste should be delivered to a landfill.

- Drained hydraulic hoses, electrical wires, control cables, seat, hydraulic cylinder seals, lights, small plastic and rubber parts.



Hazardous waste is delivered to a collection point for hazardous waste.

- Oils: hydraulic oil, transmission oil from the slewing system
- Solid lubricants: greases from the joints and journal bearings
- Other waste containing oils and greases: hydraulic oil filters.



European Union—Disposal Information

This symbol identifies the parts of your crane that need to be disposed of separately from household waste according to EU legislation. When one of these parts reaches the end of its life, take it to a collection site designated by local authorities. Responsible collection and recycling help protect natural resources, the environment, and human health.

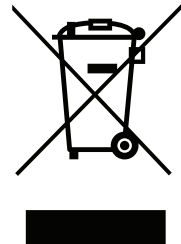

10. Technical Data

10.1. Load plate table

When the crane has VSL [option], the Installer should fill in the valid meters (**m**) or feet (**ft**) and kilos (**kg**) or pounds (**lb**) in this table, following instructions given in the Installation instructions.

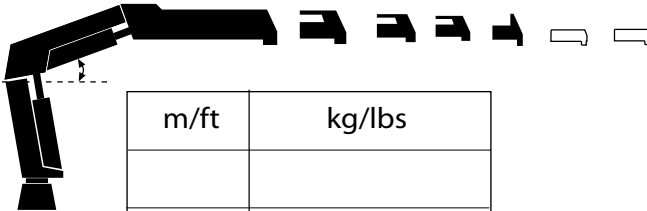

m/ft	kg/lbs

10.2. Identification of the loader crane

The information below is to be filled in by the installer. The same information will be found on the serial number plate on the crane:

Mark: HIAB

Type:

Serial number:

Manufact. year:

 HIAB LOADER CRANE
TYPE <input type="text"/>
SERIAL NO <input type="text"/>
MANUF.YEAR <input type="text"/>
<small>Cargotec</small>

10.3. Abbreviations

- ADC - ('Automatic Duty Control') - Automatic Duty Control
- ADO - ('Automatic Dumping of Oil') - Automatic Dumping of Oil
- APO - ('Automatic Power Off') - Automatic Power Off
- ASC - ('Automatic Speed Control') - Automatic Speed Control
- BDA - ('Boom Deployment Assistant') - Boom Deployment Assistant
- CTC - ('Crane Tip Control') - Crane Tip Control
- DA modules - ('Digital Amplifier Modules') - Digital Amplifier Modules
- JDC - ('Jib Dual Capacity') - Jib Dual Capacity
- LSS-H - ('Load Stabilising System-Horizontal') - Load Stabilising System-Horizontal
- LSS-V - ('Load Stabilising System-Vertical') - Load Stabilising System-Vertical
- MEWP - ('Mobile Elevating Work Platform') - Mobile Elevating Work Platform
- MSC - ('Manual Speed Control') - Manual Speed Control
- MUX - ('Multiplexer Box') - Multiplexer Box
- OLP - ('Overload Protection') - Overload Protection
- OPS - ('Operator Protection System') - Operator Protection System
- PFD - ('Pump Flow Distribution') - Pump Flow Distribution
- PSB - ('Power Supply Box') - Power Supply Box
- SAF - ('Semi Automatic Folding') - Semi Automatic Folding
- SCB - ('Stabiliser Control Box') - Stabiliser Control Box
- SPA - ('Slew Parking Assistant') - Slew Parking Assistant
- SSL - ('Sector Stability Limit') - Sector Stability Limit
- UI - ('User Interface') - User Interface
- VSL - ('Variable Stability Logic') - Variable Stability Logic
- VSL+ - ('Variable Stability Logic Plus') - Variable Stability Logic Plus

10.4. Daily inspection checklist

Operator			Document ID:	
Crane s/n:			Date:	
DAILY INSPECTION	✓	✗	⊘	Comments
Presence of signs and symbols				
Locking devices				
Spirit level				
Shafts, locking shafts, bearings and bushings				
Crane structure				
Hooks				
Add-on equipment and separate lifting accessories				
Electronic components				
Security seal wires				
Hydraulic system and oil level in the tank				
Oil level in the slewing housing and condition				
Oil level in the slewing motors and condition				
Filters				
FUNCTIONAL TESTS				
Emergency stop buttons				
Levers				
Controller				
Horn and LED test				
<p>If you find a fault that prevents you from operating the crane safely, contact a Hiab authorised service workshop. Do not try to repair the fault, it can cause you injury or you can damage the equipment.</p> <p>Permission to reproduce this checklist is granted; however please note that only the original document owned by Hiab will contain necessary amendments and updates. Hiab shall not be held liable if the copy in your possession does not contain the latest changes.</p>				

10.5. Monthly inspection checklist

Operator			Document ID:	
Crane s/n:			Date:	
MONTHLY INSPECTION	✓	✗	⊘	Comments
Piston rods				
Pivot pins and bushes				
Bolts and screw fixings				
Cables and sensors				
Lubrication schedule				
Slewing bearing / Upper column bearing				
Pump attachment screws				
Gateway connectivity				

If you find a fault that prevents you from operating the crane safely, contact a Hiab authorised service workshop. Do not try to repair the fault, it can cause you injury or you can damage the equipment.

Permission to reproduce this checklist is granted; however please note that only the original document owned by Hiab will contain necessary amendments and updates. Hiab shall not be held liable if the copy in your possession does not contain the latest changes.