

# **Operator's Manual GB HIAB X-HiPro 358-408-418 X4**

This operator's manual is an Original Instruction  
and applies to cranes with serial number from:  
3580001, 4080001, 4180001

2018-01

---

## Congratulations with your new crane!

You are now the owner of a quality product from Cargotec, built to the highest standards of safety and quality.

The aim of this manual is to help you handle your crane safely and with full satisfaction.

Please read the complete manual. It provides detailed information about the crane, control system and the practical management and maintenance of the crane.

We advise you to read it carefully and familiarize yourself with your crane before you start to use it.



Help us to improve this manual. Please send your comments and suggestions to [documentation@hiab.com](mailto:documentation@hiab.com)



This manual includes interactive contents.

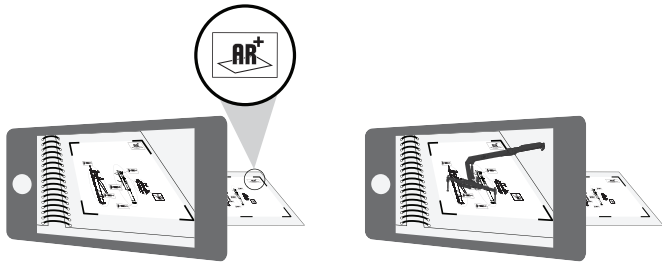

Download the '**Hiab AR+ App**' for the interactive content in this manual. Look for the **AR+** symbol. Use your device to scan the image next to the symbol.

The interactive contents in the Hiab AR+ App will display suggestions to make the crane operation easier for you to understand. However, note that some of the content included in the 'Hiab AR+ App' may differ from the actual configuration of your crane and is subject to updates and changes from Hiab without prior notice.

# Table of Contents

---

1.	Introduction.....	7
1.1	This Operator's Manual is intended for operators of this HIAB crane. ....	7
1.2	Cleanliness certificate .....	8
1.3	Indications in the Operator's Manual .....	8
2.	Structure and parts of the HIAB crane.....	12
2.1	Main groups .....	12
2.2	Crane base with column and slewing system .....	12
2.3	Stabiliser system.....	13
2.4	Boom system .....	13
2.5	Accessories on the boom system .....	14
2.6	Operating system - hydraulic components .....	17
2.7	LHV Load holding valves .....	18
2.8	Description of HIAB X-HiPro 358-408-418 .....	18
2.9	Accessories that can be fitted in a X-HiPro 358-408-418.....	19
3.	Safety precautions and warnings.....	20
3.1	Operating conditions .....	20
3.2	Wind speeds .....	21
3.3	Definition of a HIAB loader crane.....	22
3.3.1	Noise declaration.....	23
3.3.2	Signs on the crane .....	24
3.3.3	Maximum load [AR+] .....	25
3.3.4	Maximum load moment.....	27
3.4	Signals when using a crane [AR+].....	29
3.5	Use of the crane .....	33
3.5.1	Preparations for use .....	35
3.5.2	Crane operation .....	36
3.5.3	Driving with the crane.....	38
3.5.4	Use of lifting equipment .....	39
3.5.5	Use of demountable cranes.....	39
3.5.6	Ending crane operation .....	40
4.	The HiPro system .....	41
4.1	Control System SPACE X4.....	41

---

# Table of Contents

---

4.2	How the safety system works.....	41
4.3	Components of the HiPro system.....	43
4.4	Standard symbols and functions of the crane and the stabiliser system ..	44
4.5	Main control valve.....	46
4.6	Different stabiliser control valves .....	46
4.7	User panel.....	47
4.7.1	Indicator LEDs on user panel.....	47
4.8	Dump valves.....	49
4.9	Pressure-reducer filter.....	50
4.10	Lamp pole [option] .....	50
4.11	XSDrive controller.....	50
4.11.1	Indicator LEDs on XSDrive controller.....	51
4.11.2	Buttons .....	52
4.11.3	Menus .....	53
4.11.4	Standard functions and symbols .....	55
4.11.5	Battery and battery charger XSDrive.....	56
4.12	CombiDrive controller.....	57
4.12.1	Displays.....	58
4.12.2	Buttons .....	60
4.12.3	Menus, standard functions and symbols.....	62
4.12.4	Battery and battery charger.....	66
5.	Starting crane operation .....	67
5.1	Starting operations [AR+] .....	67
5.2	Set the stabiliser system.....	69
5.2.1	Stabiliser system and ground conditions .....	71
5.2.2	Activate the stabiliser system.....	72
5.2.3	Extend the stabiliser extensions.....	72
5.2.4	Set the stabiliser legs [AR+].....	73
5.3	Operate the boom system out of transport position .....	77
5.3.1	BDA Boom Deployment Assistance [AR+].....	79
6.	During operation .....	81
6.1	Functions .....	81
6.1.1	Controlling the crane speed with the controller XSDrive .....	81

# Table of Contents

---

6.1.2	Controlling the crane speed with the controller CombiDrive.....	81
6.1.3	Supervision of spools .....	82
6.1.4	APO Automatic power off.....	82
6.1.5	ADO Automatic dump function .....	82
6.1.6	ASC Automatic Speed Control.....	83
6.1.7	ADC Automatic Duty Control.....	83
6.1.8	PFD Pump flow distribution .....	83
6.1.9	Slewing sector [option].....	84
6.1.10	LSS-V Load stabilising system-vertical [Option].....	84
6.2	OLP (Overload protection).....	85
6.3	OLP - indications on the controller .....	86
6.3.1	XSDrive.....	86
6.3.2	CombiDrive.....	86
6.4	To release OLP .....	87
6.5	Manual extensions [option] .....	88
7.	Ending crane operation .....	92
7.1	Operate the boom system into transport position .....	92
7.1.1	Operate the boom system.....	93
7.2	Placing the stabiliser system in the transport position.....	94
7.3	Switching off the control system .....	98
7.4	Emergency operation Valve-V200 .....	99
7.5	TWI Transport warning interface [option] .....	100
8.	Maintenance and Service.....	102
8.1	Service.....	102
8.2	Warranty .....	103
8.3	Follow the maintenance instructions!.....	104
8.3.1	Daily inspection.....	105
8.3.2	Monthly inspection and maintenance .....	108
8.3.3	Annual maintenance .....	109
8.4	Lubrication .....	110
8.4.1	Lubrication schedule [AR+].....	111
8.4.2	Lubrication of the gearbox.....	112
8.4.3	Lubrication of the slewing bearing .....	112

## Table of Contents

---

8.4.4	Lubrication of bearing assemblies .....	113
8.4.5	Lubrication of slide pads in the boom system.....	115
8.4.6	Lubrication of the hooks .....	116
8.5	Hydraulics .....	116
8.5.1	Replacing the cartridge in return oil filter .....	116
8.5.2	Replacing the cartridge in pressure-reducer filter - V200.....	117
8.5.3	Replacing the cartridge in pressure-reducer filter - V80R .....	118
8.5.4	Replacing the cartridge in high pressure filter .....	121
8.5.5	Checking the oil tank level .....	123
8.5.6	Changing the hydraulic oil.....	123
8.5.7	Bleeding air from the hydraulic system .....	126
8.6	Troubleshooting.....	126
8.6.1	Main fuses .....	126
8.6.2	Faults on the crane .....	128
8.6.3	Display [option].....	131
9.	Decommissioning.....	133
9.1	Decommissioning a crane.....	133
10.	Technical Data .....	135
10.1	Documentation .....	135
10.2	Identification of the loader crane .....	135
10.3	Abbreviations .....	136
10.4	Daily inspection checklist to photocopy .....	137

## 1.1 This Operator's Manual is intended for operators of this HIAB crane.

**This manual describes:**

- Operation
- Safety precautions and warnings
- The crane control system
- Maintenance and troubleshooting

**Enclosed to this manual the Installer will provide:**

- Technical Data for your crane
- Technical Data and manuals for add on equipment if fitted

**Study these instructions carefully**



### **DANGER**

If you do not study the complete Operator's Manual for your crane carefully, it could lead to fatal accidents or serious damage.

**Therefore you should:**

- Study the entire Operator's Manual carefully.
- Study the operating manuals for other add-on equipment, if fitted.
- Use the crane only after having done so.
- Follow the directions for use, operation and maintenance of the crane and add on equipment exactly.
- Store the Technical Data and manuals from the Installer, together with this Operator's manual.



### **! NOTE**

The manufacturer reserves the right to change specifications, equipment, operating instructions and maintenance instructions without prior notice.

**NOTE**

HIAB shall at all times have the right to:

- install, maintain and dismantle automated remote diagnostics system or similar sensor-based system (the “System”) in and from the Equipment; and
- access, send, receive, collect, store and use any and all information and data gathered or created by such System including but not limited to information concerning operation, operating environment, movement, condition, logon, location and similar information relating to the Equipment (the “Information”).

The Customer shall not in any way remove or alter the System, nor interfere with the use of the System or the Information. The System and the Information and all their further developments shall at all times be and remain the exclusive property of HIAB without granting any right or license to the customer.

## 1.2 Cleanliness certificate

All Hiab equipment has been tested and certified at the factory according to the Hiab Standard C250.52 that defines the Cleanliness Requirements for Hydraulic Systems. This means that they fulfil the cleanliness class **20/18/14** measured by the ISO 4406 standard.

All hydraulic functions have been individually tested and fully comply with the defined requirements.

## 1.3 Indications in the Operator’s Manual

### What must you do and not do?

The following indications are used in the Operator’s Manual:





## **DANGER**

Danger to life for yourself or to bystanders.  
Follow the instructions carefully!



## **WARNING**

Danger of injury to yourself or to bystanders,  
or danger of serious damage to the crane or  
other objects.  
Follow the instructions carefully.



## **CAUTION**

Hazard for the crane or crane components.  
Follow the instructions carefully.



### **Important:**

If actions are numbered

1. Do this
2. Do that
3. ....
4. ....
5. ....

you should carry them out in numerical order!



### **! NOTE**

Extra information that can prevent problems.



### **TIP**

Tip to make the work easier to carry out.

### Symbol for reference to a component in an illustration.

① Refers to a component in an illustration.

[option]: Indication for parts that are not-standard for the crane, but are an option. Not all [option] are available for your crane.

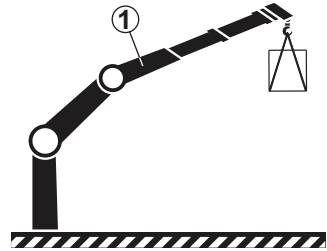

#### DANGER

Only persons with the requisite knowledge and experience with cranes may use the crane. Never operate the crane when you are sick, tired, under the influence of medicines, alcohol or other drugs.

- Take the delivery instructions from your HIAB Service workshop, or receive instruction from an experienced person from your own company. Only then should you operate your crane.
- Ensure that you comply with the statutory requirements of the country in which you use the crane (for example, certificate, obligatory safety-helmet).



#### DANGER

- Carry out yourself only the service and maintenance work you have the requisite knowledge and experience of.
- All other maintenance work may only be carried out by a HIAB service workshop.
- Ensure that every defect is rectified immediately, according to the instructions.
- Follow the instructions exactly!
- All other work to rectify faults must be performed by personnel in a HIAB service workshop!

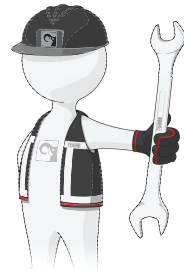

**WARNING**

- Never clean the electronic system, plastic components, signs or bearings with a high-pressure jet cleaner. It could cause damage.
- Never expose the electronic system to high electrical voltages. This could damage the control system.
- Never immerse the controller in water or other liquid. This will make the controller unusable.

If your crane is equipped with add-on lifting equipment (hoist, rotator, etc.):

- The operation of the crane with add-on lifting equipment can differ from the operation as described in this manual.
- You should therefore study the Operating Manual for the add-on equipment carefully, before you use the crane.
- Take particular note when placing the crane in to or out of transport position.

## 2.1 Main groups

**This HIAB crane consists of the following main groups:**

- Crane base with column and slewing system
- Stabiliser system
- Boom system
- Operating system - hydraulic components

**Some accessories can be fitted depending on your crane configuration:**

- Manual extensions [option]
- Hoist [option]
- JIB [option]
- Add-on lifting accessories [option]
- Hooks [option]
- Separate lifting accessories [option]

## 2.2 Crane base with column and slewing system

**The crane base, column and the slewing system consist of the following components:**

- Crane base ①  
with stabiliser beams ② and three-point bridge ③.
- Column ④  
fitted to the crane base.
- Continuous slewing system ⑤  
composed by a slewing bearing and 1 or 2 hydraulic motor reducers.

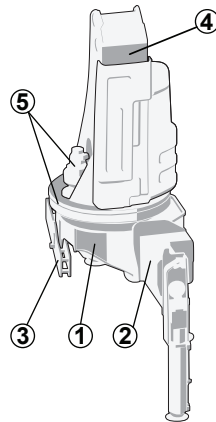

## 2.3 Stabiliser system

Every HIAB crane is equipped with two stabiliser extensions and two stabiliser legs. Auxiliary stabiliser systems may be needed for heavy cranes. The stabiliser system consists of:

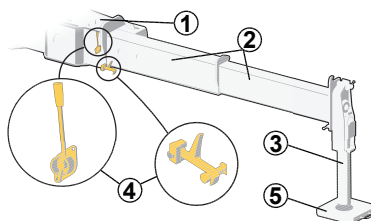

- ① Stabiliser beam
- ② Stabiliser extensions
- ③ Stabiliser legs
- ④ Stabiliser locking devices [option]
- ⑤ Extra support plates

## 2.4 Boom system

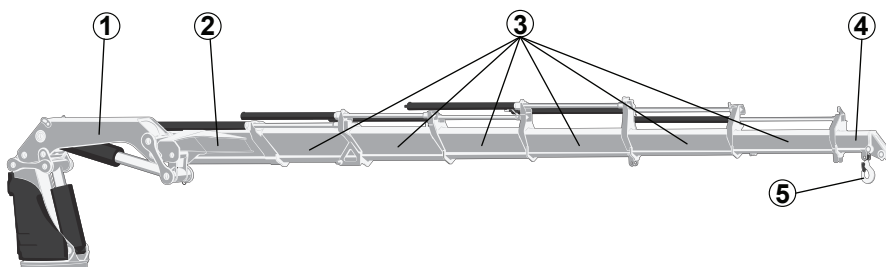

The boom system consists of the following components:

- ① 1st boom
- ② 2nd boom
- ③ Hydraulic extensions  
The length of the hydraulic extension depends on the type of crane.
- ④ Manual extensions [option]
- ⑤ Hook [option]

## 2.5 Accessories on the boom system

### Manual extensions [option]

Manual extension is slid by hand into the hydraulic extension.

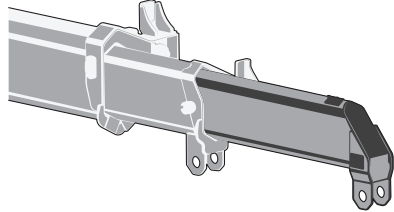

### Hoist [option]

The hoist is a crane accessory which permits load handling without any or only limited boom movement. An obvious advantage is that the hoist makes it possible to handle loads far below ground level. Lifting and lowering is achieved by winding/ unwinding the rope. A number of auxiliary components are needed, such as intermediate pulleys and a hook pulley. As an option, a snatch block can be installed to duplicate lifting capacity.

**The Hoist consists of the following components:**

- Wear plate ① for rope end monitoring
- Pressure roller ②
- Rope ③
- Load sensor ④
- Electrical wire to load sensor ⑤
- Electronic box ⑥
- Switch ⑦ for 3-rolls left to rope end monitoring
- Motor ⑧

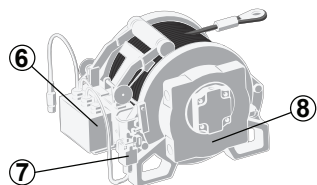
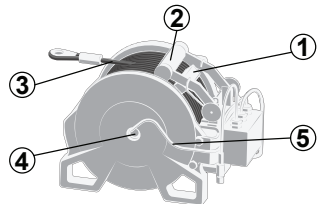

**JIB [option]**

The JIB is an additional, folding, lifting device that extends the crane boom. Use the JIB so as to be able to reach further.

**The JIB consists of the following components:**

- JIB boom ①
- JIB cylinder ②
- JIB extension ③
- JIB extension cylinder ④
- JIB manual extension [option] ⑤
- JIB support / JIB long support [option] ⑥

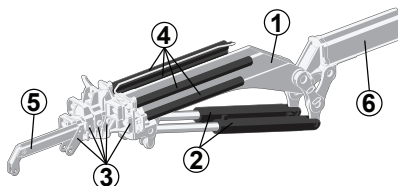
**Add-on lifting accessories [option]**

Add-on lifting accessories are placed between the boom tip and the load (e.g. brick grapple, rotator) or on the crane (hoist).

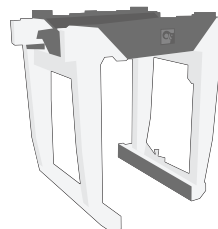
**Hooks [option]**

Different hooks can be mounted depending on the crane model.

**DANGER**

Never exceed the maximum permissible loading of the hook.

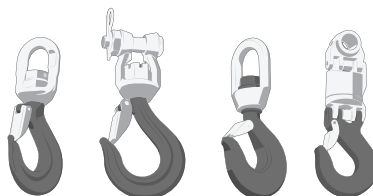

**Separate lifting accessories [option]**

Separate lifting accessories, help to make or use a slinging device: eye-hooks, shackles, eye-bolts etc.





## 2.6 Operating system - hydraulic components

The operating system consists of the following hydraulic components:

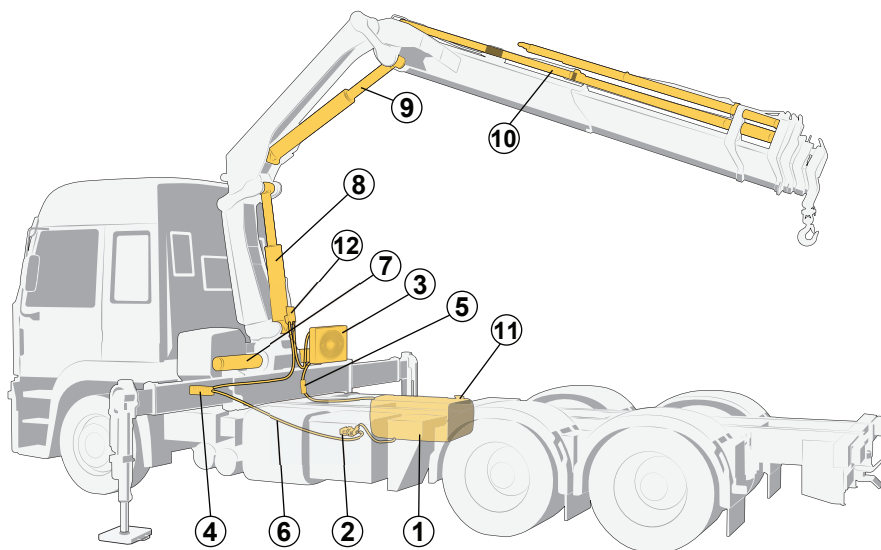

① Oil tank	⑤ Stabiliser control valve [option]	⑪ Return filter
② Hydraulic pump	⑥ Hydraulic hoses and lines	⑫ Load holding valve
③ Oil cooler [option]	⑦ Slewing cylinders / Motor reducers	Pressure filter [option]
④ Main control valve	Actuators: ⑧ First boom cylinder ⑨ Second boom cylinder ⑩ Extension cylinder/s	

## 2.7 LHV Load holding valves

All cylinders are equipped with load-holding valves as a safety device. After a crane movement they hold the crane in position, also in the unlikely event of a burst hose.

If there is a leak or a component fractures, such as a pipe, hose or a coupling, the load-holding valves will stop the booms from collapsing down, even when the hydraulic system is switched off, and you operate a particular crane function.

To operate a hydraulic cylinder equipped with a load holding valve, an opening pressure is required.

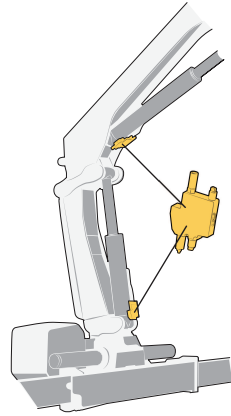

## 2.8 Description of HIAB X-HiPro 358-408-418

The HIAB X-HiPro 358-408-418 are compact, fully hydraulically operated goods cranes.

Lifting capacity:

- HIAB X-HiPro 358 = 33.6 tonne metres
- HIAB X-HiPro 408 = 38 tonne metres
- HIAB X-HiPro 418 = 39.6 tonne metres

The crane is supplied in many versions from:

- HIAB X-HiPro 358/408 E-4 (reach 11.8 metres) to HIAB X-HiPro 358/408 E-8 (reach 21.8 metres)
- HIAB X-HiPro 418 EP-2 (reach 8 metres) to HIAB X-HiPro 418 EP-5 (reach 15.1 metres)

The control valve V200, a controller (Combi-Drive or XSDrive) and SPACE X4 safety system are standard equipment on the HIAB X-HiPro 358/408/418.

The crane type and the manufacturer are marked on the serial number plate.



### ! NOTE

The exact technical information for your crane is shown in the Technical Data.

**2.9 Accessories that can be fitted in a X-HiPro 358-408-418**

<b>JIBS</b>	<b>available in combinations:</b>
<b>70X</b>	358/408 E-5/6 + JIB70X-3/4
<b>100X</b>	358/408 E-4/5 + JIB 100X-2/3/4/5

<b>Hoists</b>	<b>available in combinations:</b>
<b>TC2</b>	418 EP-2/3/4/5 + TC2
<b>TC2L.</b> Not compatible with manual extensions in: - 358/408 E-8 - JIB70X-4	358/408 E-4/5/6/7/8 + TC2L
	358/408 E-5/6 + JIB70X-3/4 + TC2L
	358/408 E-4/5 + JIB 100X-4/5 + TC2L
<b>Snatch block</b> for TC2 and TC2L	Available in all combinations, except in the configuration 358 E-8

<b>Manual extensions</b>	<b>available in combinations:</b>
1 manual extension in crane	418 EP-5 + 1
	358/408 E-8 + 1
1 manual extension in JIB	358/408 E-5/6 + JIB70X-4 + 1

### 3.1 Operating conditions

You may only use the crane under the following conditions:

- In the open air, or in spaces with sufficient ventilation.
- With a mean wind velocity less than 13.3 m/sec (approx. 29.7 mph). **See the wind speed table.**



#### DANGER

- If you use the crane in a confined space you could suffocate from the exhaust gases from the vehicle.
- Never use the crane in a high wind or storm. When the mean wind velocity exceeds 13.3 m/sec (approx. 29.7 mph) the crane will behave unpredictably. **Never** use the crane during a thunderstorm.
- **Never** use the crane at temperatures below -40°C (-40°F), as the steel's properties deteriorate below this temperature.



#### WARNING

- At temperatures below 0°C (32°F):  
Do **not** touch the operating levers during the first few minutes.
- When starting in cold weather, the wear on the hydraulic system is greater than at normal working temperatures.

To get a good function of the crane, it should be started as follows:

- Engage the power take-off at low rpm.
- Allow the system to idle for a few minutes.
- Operate stabiliser legs up and down for one minute, in order to warm up the oil.



### 3.2 Wind speeds

Wind speed averaged over 10 minutes at a height of 10 m

Wind Force	Above flat ground		Characteristics
	m/s	Wind type	
0	0.0 - 0.2	Calm	Calm, smoke rises vertically or nearly vertically
1 2	0.3 - 1.5 1.6 - 3.3	Slight breeze	Wind direction recognisable from smoke plumes, the wind begins to be noticeable on the face; leaves begin to rustle and weather vanes can start to move.
3 4	3.4 - 5.4 5.5 - 7.9	Moderate wind	Leaves and twigs in continuous movement, small branches begin to move. Dust and paper begin to move over the ground.
5	8.0 - 10.7	Fairly strong wind	Small leaved branches make swaying movements; crested waves form on lakes and canals.
6	10.8 - 13.8	Strong wind	Large branches move; you can hear the wind whistling in telephone wires; umbrellas can only be held with difficulty.
7	13.9 - 17.1	Severe wind	Entire trees move; the wind causes difficulty when you walk into it.
8	17.2 - 20.7	Stormy wind	Twigs break off, walking is difficult.
9	20.8 - 24.4	Storm	Causes superficial damage to buildings (chimney pots, roof-tiles, and TV antennae are blown off).
10	24.5 - 28.4	Severe storm	Uprooted trees; considerable damage to buildings etc. (occurs infrequently on land).
11	28.5 - 32.6	Very severe storm	Causes extensive damage (occurs very infrequently on land).
12	> 32.6	Hurricane	

### 3.3 Definition of a HIAB loader crane

#### Usage of the crane

The HIAB loader crane is used to lift and move loads in the working area permitted by the load plate and the load diagram. The cranes are normally mounted on a vehicle but they can also be mounted on a fixed base plate. The crane can be equipped with a number of accessories.

Loader cranes are designed for loading and unloading the vehicle, as well as for other duties as specified:

#### Permitted duties:

- Loading and unloading cargo from/to a vehicle
- Lifting of loads from the ground/vehicle to a higher place
- Installation work (beams, concrete plates, windows...) in building constructions
- Lifting construction material (wall boards, bricks, blocks...) on a pallet fork to a building, taking the material from the vehicle on which the crane is mounted, from another vehicle or from the ground
- Hoisting, e.g. beams, concrete plates and any other material and equipment used in building construction
- With a bucket, moving filling material at a construction site
- Handling large loads (containers, boats, machinery, vehicles...)
- Collection of waste and recycling material (glass, paper, cardboard, plastic...)
- Installation of informative posts, road signs, notice boards, traffic lights, street lights...
- Handling submerged pumps in wells, using a hoist

**Forbidden duties:**

- Crane mounted onboard ships or floating structures, only permitted in cases authorized by HIAB
- Continuous use as a production crane in assembly lines, foundries..., except for cranes prepared for that purpose
- Handle loads, work with submerge boom system or accessories, in strong currents such as rivers
- Loading cargo that is partially loaded or fastened by other means, without making sure the capacity of the crane is enough for the entire load
- Any duty which implies:
  - Pressure against the ground, unless the crane is specifically prepared for this
  - Push/pull with the boom system against any type of obstacle (wall, ground...)
  - Using the JIB upside down [HiPro cranes], except JIBs prepared for that. (See Operator's Manual for your JIB).

**DANGER**

Lifting people with a crane is never allowed unless it is a MEWP crane.

**3.3.1 Noise declaration**

The following values for emitted noise may be taken as general and conservative values for ordinary installations of loader cranes on normal diesel engine powered trucks. Declared dual-number noise emission values in accordance with ISO 4871:

- Emitted A-weighted sound power level for basic loader cranes in accordance with ISO 3744:  $L_{wA} = 103$  dB (Uncertainty:  $K_{wA} = 2$  dB).

### 3.3.2

## Safety precautions and warnings

- Emitted A-weighted sound power level for loader cranes with hoist in accordance with ISO 3744:  $L_{wA} = 107$  dB (Uncertainty:  $K_{wA} = 2$  dB).
- A-weighted sound pressure level at loader crane control stations in accordance with ISO 11201:  $L_{pA} = 95$  dB (Uncertainty:  $K_{pA} = 4$  dB).

Particular installations can be quieter, in which case a post installation noise measurement in accordance with clause 6.3 of EN 12999:2011 may be used to prove this.

### 3.3.2 Signs on the crane

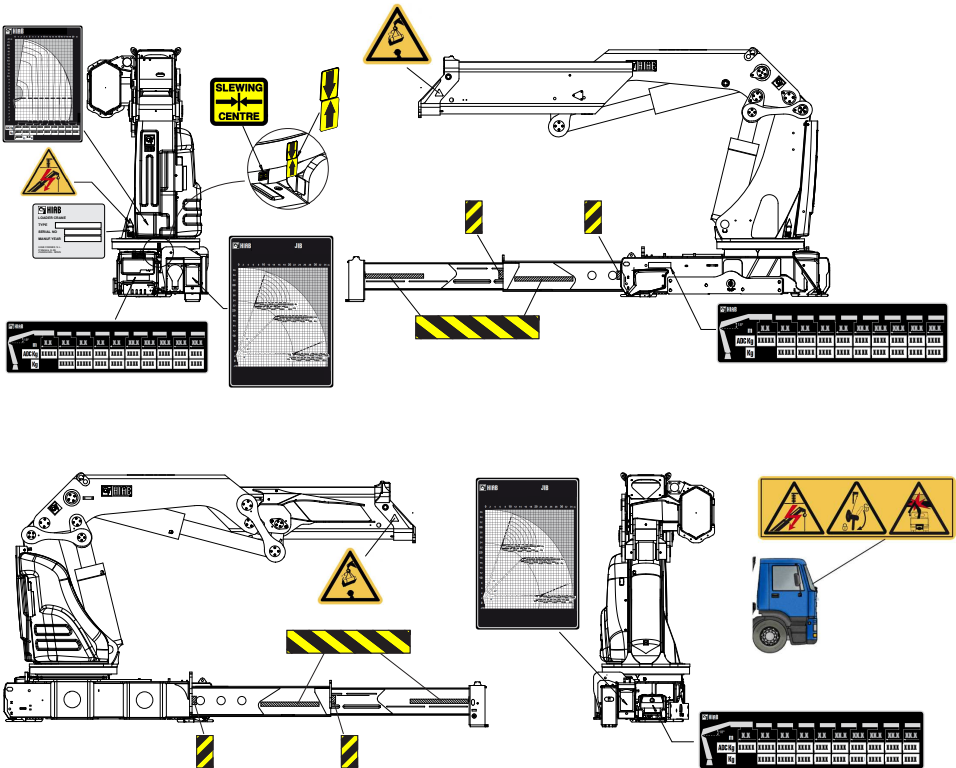



### 3.3.3 Maximum load [AR+]

#### Lifting capacity

Your crane has a certain lifting capacity, expressed in kNm or tm. This lifting capacity is also known as the load moment. The lifting capacity is: the payload at hook multiplied by the outreach in metres that the crane can operate at different positions. The lifting capacity of your crane determines the maximum load your crane may lift within its working zone. However take careful note; the greater the operating radius of the crane, the lower the lifting capacity will be because of the weight of the boom system itself. The load plate and the load diagram on your crane show the maximum loads you may lift in the operating reach of your crane.

 **DANGER**

- Overloading could result in damage to the crane or in the worst case, personal injury or death
- Never increase a hanging load, since that may cause a load holding valve to open and/or the vehicle to turn over.
- Never use the crane with the OLP system switched off.

#### ! NOTE

The extra weight of the lifting accessories has to be added to the load. Thus, with lifting accessories the load you can lift is less heavy

#### Load plate

On the plate is the maximum weight that you may lift at a given reach, with the 1st boom in the optimum position. In chapter Technical Data in this manual you will find these values for your crane.

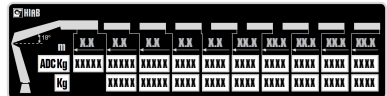

m		X.X	X.X	X.X	X.X	X.X	X.X	X.X	X.X	X.X	X.X	X.X	X.X	X.X
ADC kg		XXXX	XXXX	XXXX	XXXX	XXXX	XXXX	XXXX	XXXX	XXXX	XXXX	XXXX	XXXX	XXXX
kg		XXXX	XXXX	XXXX	XXXX	XXXX	XXXX	XXXX	XXXX	XXXX	XXXX	XXXX	XXXX	XXXX

### Optimum position

The weight that your crane can lift will be determined by:

- stabiliser extensions positioned and legs pressed to ground.
- The reach at which you are working and the optimum position of the boom.
- The optimal position for your crane is on the load plate.



#### DANGER

**Never** exceed the maximum weight on the load plate.

### Load diagram

The load diagrams are placed on the column and show the maximum loads your crane / JIB (if fitted) / hoist (if fitted) may lift in the entire working zone (manual extensions excluded). The load diagram drawing will also be found in the enclosed Technical Data.

**The white area is the working zone of the crane.**

The load curves show the maximum load that may be lifted at a given reach and height. For a given maximum load, the possible working zone is to the left of the load curve. The lifting capacity for some cranes is limited in the high lifting area.

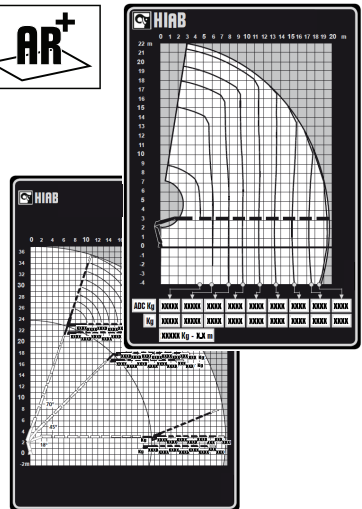

#### WARNING

Care must be taken when handling loads in the high lifting area, so the load/tool does not come into contact with the boom system.

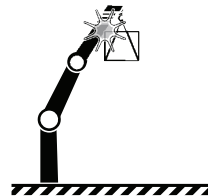



## WARNING

Never operate the hydraulic extensions against a solid object when the first boom is completely lifted. Do not try to push or compress loads when the first boom is fully lifted, as this could cause damage to the first boom cylinder.



### 3.3.4 Maximum load moment

If your crane has reached the maximum load moment (lifting capacity), the OLP gives a warning and locks any crane movement that will increase the load moment. This is known as an OLP situation.

If the second boom is raised, then the following movements are locked:

- first boom down/up
- second boom down
- extension boom out

If the second boom is down, then the following movements are locked:

- first boom up
- second boom up
- extension boom out
- first boom down (certain crane types and cases)

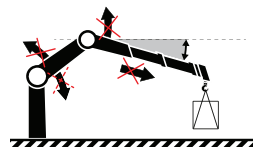
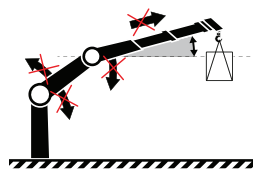

### Lifting the load

You obtain the best from your crane in this way: Ensure that you always have the work in clear view. If you cannot see the load properly, you could cause a fatal accident or serious damage.

### Sling length

Always attach the load using the shortest possible sling. The angle between the legs of the sling must not exceed  $120^\circ$ . The maximum working load (usually known as the working load limit (WLL) in standards) of a multilegged sling for general purposes is calculated by multiplying the WLL of a single leg by a mode factor, in accordance with the table.

Max angle to the vertical of any sling leg (degrees)	Mode factor two legged sling	Mode factor three and four legged sling
0-45	1,4	2,1
45-60	1,0	1,5

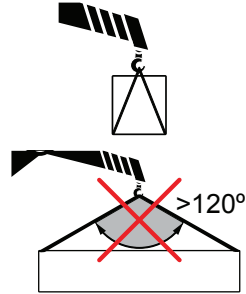

If the angle between the legs of the sling exceeds  $90^\circ$ , the slings should not be hung directly on the hook, but rather be slung from a ring that is hung on the hook.

### Working close to the load

Always try to lift the load with the extension boom retracted, however not completely. The crane then has the greatest lifting capacity. Place the vehicle as close as possible to the load.

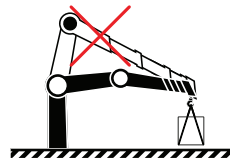

### Working below ground level

If you have to load or unload below the level of the ground: keep the first boom angle to about  $10^\circ$  to  $30^\circ$  above the horizontal plane.

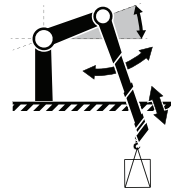

### Heavy loads

Lift heavy loads with the second boom in the optimum position in relation to the first boom. For this, see the load plate on your crane.

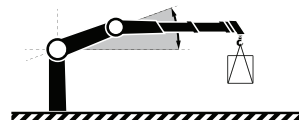

**DANGER**

Never exceed the maximum permissible loading of the hook.

**Heavy loads cannot be handled with the boom straight.**

Set the second boom, so there is an angle in relation to the first boom.

**Loads at the extreme limit of the working zone**

Also in this case, angle down the second boom somewhat. Only use the first boom .

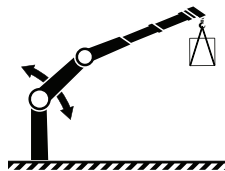
**TIP**

Make smooth crane movements: operate the crane with various functions simultaneously. In this way you will also prevent the hydraulic system heating up quickly.

### 3.4 Signals when using a crane [AR+]

**DANGER**

- If it is not possible to see the load and the entire working area clearly the crane operator is obliged to follow the instructions and signals given by a qualified person qualified.
- The country-specific regulations for crane operator signals are to be used.

Signals in this manual give a number of standard signals that can be used.

**Lift**

Raised arm and index finger raised. Circular motion with hand.

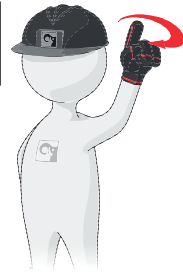
**Lower**

Arm pointing downwards and index finger down. Circular motion with hand.

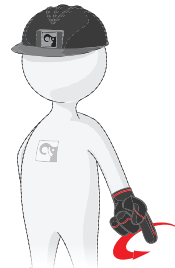
**Stop all crane movements**

Also: **Hold the load in position.**

Raise the open hand, with the palm clearly visible, and arm at shoulder height.

Keep the hand still.

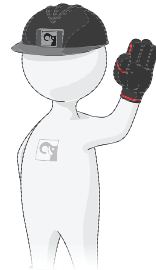
**Emergency stop for all movements by the crane.**

Raise the hands and the arms to an oblique angle.

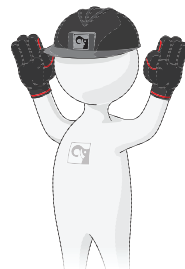

## Very short movement

Place the hands a very short distance apart, with the palms facing each other. The hands may be held either horizontally or vertically. The next movement may be: Lift, lower, move the lifting gear, change the reach, or turn.



## Change the reach

Signal with your hands.

- Sideways movement outwards with both hands. Thumbs outwards.
- Sideways movement inwards with both hands. Thumbs inwards.

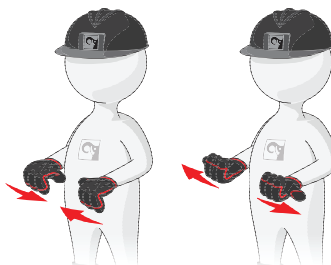

## Turn in the direction indicated

Indicate the direction with the hands.

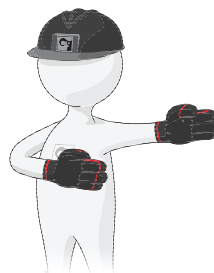

## Open the grapple

Extend the arms at shoulder height, with the palms facing downwards.

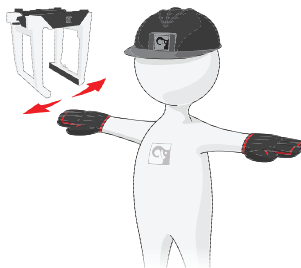

**Close the grapple**

Move both hands close together.

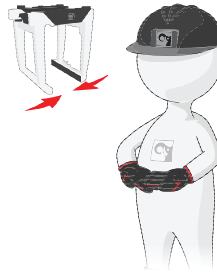
**Lift the open grapple a little**

Extend both arms at shoulder height, with the palms facing upwards. Make vertical movements with both arms outstretched.

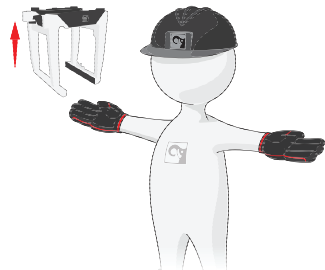
**Keep the grapple in position briefly**

Raise the hand drooping slightly, with the fist clenched.

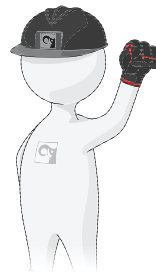



## 3.5 Use of the crane

### Starting crane operation



#### DANGER

- Wear a safety helmet (compulsory in some countries!).
- Check that the ground is sufficiently flat and firm.
- To ensure that the vehicle stays in its position, always engage the parking brake and place chocks under the wheels.
- Check that the ground is not undermined. Look out for sewers, cellars, excavations etc.

- The stabiliser legs must not be able to sink in! Use support plates that are large and firm enough for your crane. The plates must not bend under load.

Check that the support plate as, it comes under load, is not pushed into the ground.

- Ensure you can see the stabiliser legs and stabiliser extensions when you are operating them.
- Do not lower the stabiliser legs on the edge of an embankment, soft shoulder, slope etc.

Lower the stabiliser legs only on to a flat and firm surface.

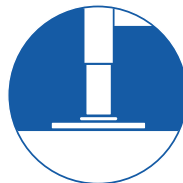

**DANGER**

- Do not stand in front of the hydraulically operated stabiliser legs when you are operating them!
- Never use the stabiliser legs as a parking brake, since the vehicle could start to slide.
- Slide the stabiliser extension, on both sides of the vehicle, out completely if possible. Then lower the stabiliser legs for support.
- Never operate the stabiliser legs, while the crane has a load!

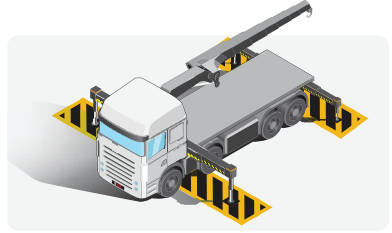
**WARNING**

- Use low force when placing the stabiliser legs on the ground.
- Do not raise the vehicle with the stabiliser legs!

If you raise the vehicle with the stabiliser legs, this may damage the stabiliser legs.

- Check that the add-on lifting accessories and separate lifting accessories are in good order!

Add-on lifting accessories are sometimes fitted on the crane (hoist, JIB) or placed between the boom tip and the load (grapple, rotator).

Separate lifting accessories are connected to the standard load hook (slings, chains, shackles etc).

**DANGER**

Do not stand in front of the boom system when operating the crane out of parking position.

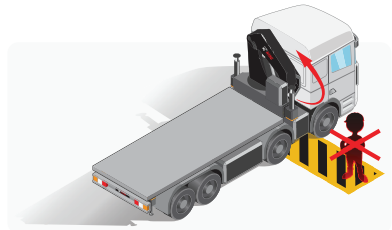

3.5.1 Preparations for use

**⚠ DANGER**  
 Ensure that there are no unauthorised persons within the operating range of your crane!

**👉 TIP**  
 Mark out the working range, e.g. with cones.  
 Put on your vehicle's warning lights.

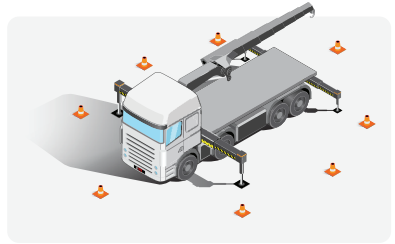

**⚠ DANGER**

- If a part of the crane comes in contact with an electricity line, you will be electrocuted!
- Maintain the following minimum distances between the crane and overhead electricity lines, unless otherwise prescribed by national rules.

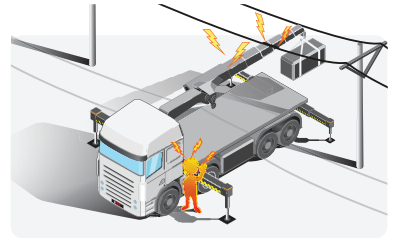

Minimum distance between crane and overhead electricity lines		
Voltage (V)	Minimum distance to an insulated conductor	Minimum distance to an un-insulated conductor
<500 V	0.5 m	2 m
500-40000 V	1.5 m	4 m
>40000 V	2.0 m	6 m
Voltages are found:		
up to 500 V:	to buildings	
500-40000 V:	trams, trains	
over 40000V:	power transmission	

### 3.5.2 Crane operation



#### DANGER

Your crane has a control system.

The control system will help you to work safely. Nevertheless, you remain responsible for safe use of the crane!

Therefore, always work according to the operating instructions!

**In an emergency immediately switch off all crane movements!**

- Push a **stop button**.

To avoid unexpected load movements and at every interruption in crane operation.



#### DANGER

- Keep checking that there are no unauthorised persons within the operating reach of the crane!
- Make certain that you can always see the load!

If your view of the load is not adequate, have someone else give you signals.

See the list of signals. Make certain that you and the person assisting you know these signals.

- Pay attention to the safety of the person giving the signals!
- Never move the vehicle, if you have a freely-suspended load on the crane!
- Never walk or stand under a suspended load!

During operation, never stand below the boom system or load!

- Do not slew the crane, nor lift the first boom, nor lift the second boom into their ends positions at full speed. This can damage the crane.



**WARNING**

- Never push a load along the ground, or the vehicle's load space, with the extension boom. This can cause damage to the boom system. This will lead to expensive repairs.
- Never use the extension boom as a jack. This could damage the slewing bearings and the connection between the crane column and the crane base.
- Always lift the load from the ground before you start to slew. Do not tow the load over the ground. This can damage the boom system.

- If you are working with loads in restricted spaces (for example, windows):

Check that the boom system can move up and down freely.

The boom system will bend somewhat, when loading and unloading the crane.

- If the boom system is in a high position (first boom above 70°), do not allow the boom to lower at full speed. The crane could go into an uncontrolled movement.

Be careful if, in particular, the OLP gives an early warning!

- When loading the vehicle:

Take the load off the stabiliser legs by withdrawing them slightly. The stabiliser legs must remain in light contact with the ground.

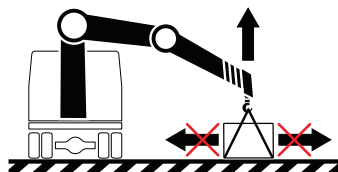
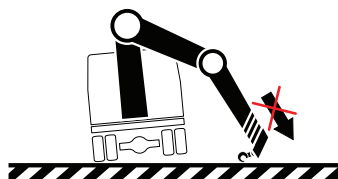
**CAUTION**

- Operate the crane using smooth and gentle lever movements.
- If a cylinder is at its end position, free the operating lever. Otherwise overheating can occur.

### 3.5.3 Driving with the crane



#### DANGER

- Never drive the vehicle if there is a load suspended from the crane.
- Before you move the vehicle:
 

Check that there is no pump flow to the main control valve. The PTO or power supply must be disengaged. The operating system must be switched off!
- Pay attention to the width and height of the crane in the transport position. The crane has to stay within the width of the truck. Make sure the stowed crane can not hit bridges, tunnels etc.
- Pay attention to overhead power lines! Make sure that no part of the crane ever comes in contact with overhead power lines.

For further instructions see vehicle's manual(s).

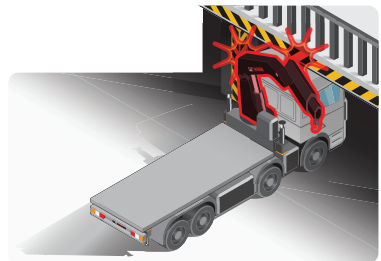
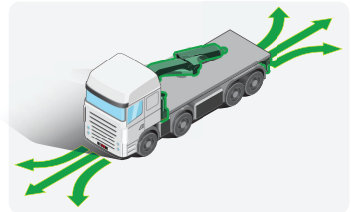
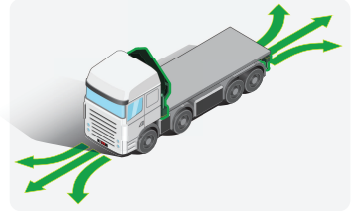

### 3.5.4 Use of lifting equipment



#### DANGER

- Only use lifting accessories (hoist, grapple, rotator) suitable for your crane. Contact a HIAB service workshop.
- Never attempt to install add-on lifting accessories yourself!
- Add-on lifting accessories may only be installed by an authorised HIAB service workshop.
- When using lifting accessories, follow the instructions supplied with the equipment!
- Watch out for hazards!
- Never try to adjust lifting accessories when you are working on the crane!

After the lifting accessories have been fitted:

1. Check that the lifting accessories are securely fixed.
2. Only after this should you use your crane.

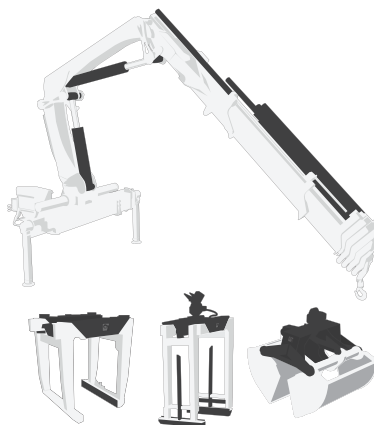

#### WARNING

- Clean the couplings, when connecting and disconnecting lifting accessories. Dirt can damage the hydraulic system.
- Take care that your fingers are not trapped

### 3.5.5 Use of demountable cranes



#### DANGER

- Ensure that there are no unauthorized persons in the immediate vicinity of the crane. When mount/demount the crane to the vehicle people can suffer fatal crushing injuries!
- After setting up:  
Check that the crane is properly locked!

**WARNING**

Take care when mounting/demounting the crane on/off the vehicle.

Roughly handling can seriously damage the crane or the vehicle.

**3.5.6 Ending crane operation****DANGER**

Always end crane operation as follows:

- After use, always place the crane in the transport position!
- Withdraw the stabiliser legs and stabiliser extensions.
- Check that the locking mechanisms are properly locked.
- Switch off the operating system.
- Disengage the PTO or power supply after work.
- If you drive with the PTO or power supply engaged, this will cause serious damage to the PTO/gearbox combination.
- Only after doing the above, should you drive the vehicle away.



## 4.1 Control System SPACE X4

SPACE X4 is a crane control system.

### The control system:

- Monitors the crane's operation and prevents unsafe actions.
- Increases the precision with which you can work.
- Makes operation easier.
- Makes troubleshooting easier.

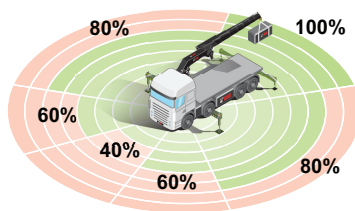

Crane version	Control valve	Control System	Controller
HiPro	V200	SPACE X4	CombiDrive XSDrive: Levers / Joysticks



### ! NOTE

The control system provides a large number of functions. Certain functions are standard, others are options.

If you do not use the system for 30 minutes, it will switch itself off in order to prevent draining the truck battery. This feature can be cancelled.

Contact your HIAB service workshop.

## 4.2 How the safety system works

On the crane there are various sensors and indicators which send signals about the crane's load, position and movements to a central micro-processor. The microprocessor then decides how the crane can be operated and stops/reduces prohibited movements/speeds according to the following:

- When prohibited movements/speeds are approached, a warning is given.
- When prohibited movements/speeds are reached:

On remote controlled cranes prohibited movements are stopped.

On manually operated cranes, all movements are stopped, because when a spool is moved too much, power to the dump valve is cut, all movements are stopped.

### **Fault monitoring**

When there is a fault in the control system it will give an immediate warning.

Depending upon the fault the crane speed and/or the load capacity will be reduced. When the fault is serious, use of the crane is blocked completely.



### **DANGER**

Never try to repair the control system yourself.  
Repairs may only be made by a HIAB service workshop!

4.3 Components of the HiPro system

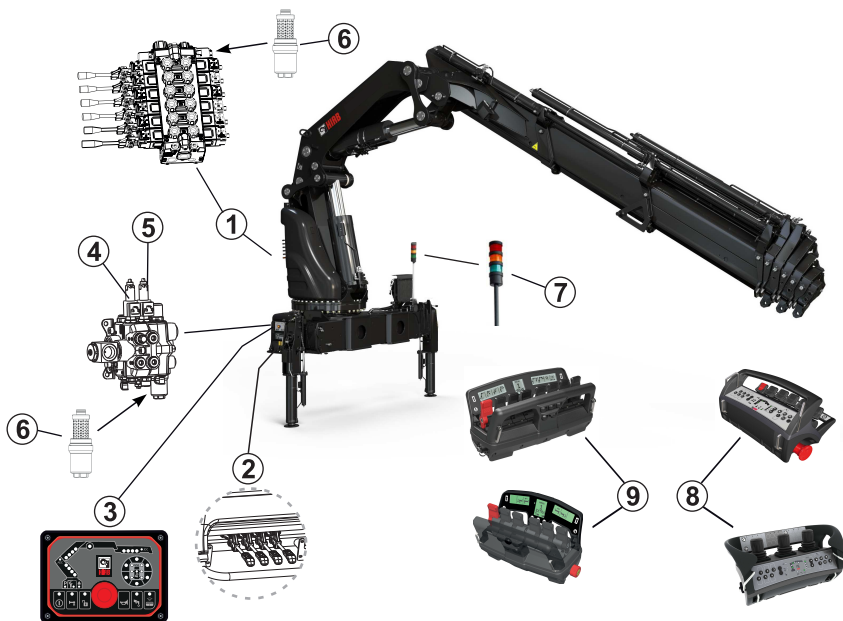

① Main control valve	④ Dump valve 1	⑦ Lamp pole [Option]
② Stabiliser control valve	⑤ Dump valve 2	⑧ XSDrive controller [Option]
③ User panel SPACE X4-UI	⑥ Pressure-reducer filter	⑨ CombiDrive controller [Option]

## 4.4 Standard symbols and functions of the crane and the stabiliser system

These symbols can be shown:

- On the plates.
- On the control valve levers.
- On the controller (If delivered).



### ! NOTE





If you use a controller to operate your crane, you can read about the symbols displayed on it in the dedicated section of this operator's manual.

Always operate the lever according to the function on the symbol sign.



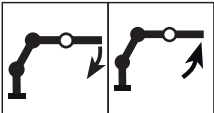
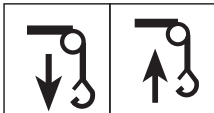

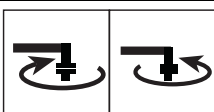
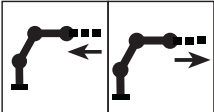
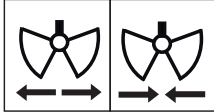



### Basic crane symbols and functions

SYMBOLS		FUNCTIONS	SYMBOLS		FUNCTIONS
		Slewing			Second boom
		First boom			Hydraulic extensions

Accessories symbols and functions (if delivered)

SYMBOLS	FUNCTIONS	SYMBOLS	FUNCTIONS
	JIB cylinder		Hoist
			Rotation tool
	JIB extensions		Tool 2
			

Stabiliser system symbols and functions (if delivered)

SYMBOLS	FUNCTIONS	SYMBOLS	FUNCTIONS
	Crane stabiliser extension		Crane stabiliser leg
			
	Auxiliary stabiliser extension		Auxiliary stabiliser leg
			

## 4.5 Main control valve

The crane can be operated from the main control valve, but as soon as you have selected remote control operation, it is impossible to operate the main control valve levers.

The speed of a function corresponds to the extent of the lever movement, regardless of the load and other functions, as long as the oil flow is sufficient. When the oil flow is insufficient, one or more functions might reduce their speed.

When remote control is used, the oil flow is allocated by means of PFD.

### Standard functions and symbols

The order of the functions is customized for each crane. The image on the right shows an example of a main control valve functions placed on the column.

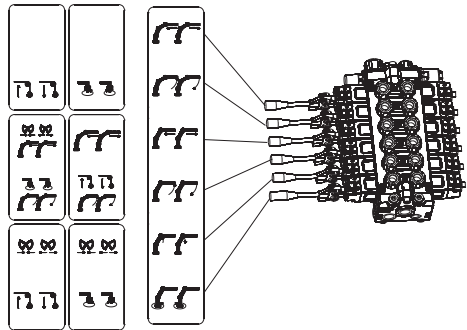

## 4.6 Different stabiliser control valves

Different stabiliser control valves that you can find on cranes:

- 2-function/4-function control valve included in the main control valve
- 2-function control valve
- 4-function control valve.

You can operate the stabiliser control valve manually or remotely. On remote-controlled cranes the stabiliser control valve levers are only to be used for emergency operation.

## 4.7 User panel





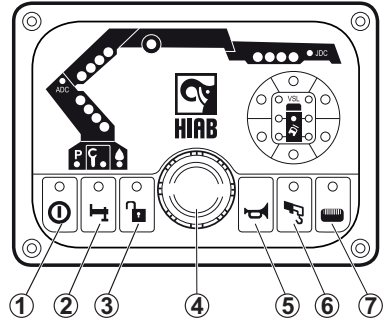



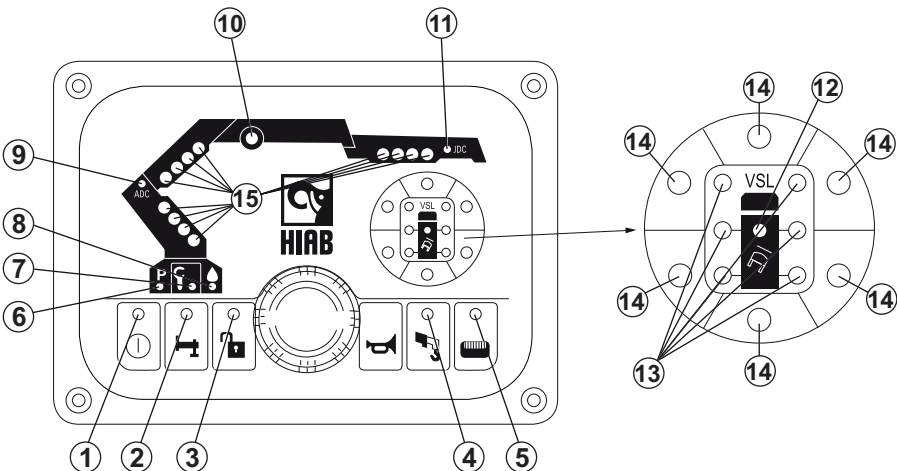

### Buttons:

- On/off button ①  
To switch the control system on and off.
  - Button ② is stabiliser operation activation to enable operation of stabiliser extensions. The driver must have full view when operating the stabiliser extensions outward.
  - Button ③ is used for OLP release if the crane is in an OLP situation and for disconnecting the automatic dump function.
  - Stop button ④ is pushed in an emergency.
  - Button ⑤
- Once the controller is activated, this button can be used to sound the crane horn.
- Button ⑥ activates OLP for manual extensions (if fitted).
  - Button ⑦ activates the controller.



### 4.7.1 Indicator LEDs on user panel



	<b>Power on/off APO</b>	①	<ul style="list-style-type: none"> <li>● Green light on: The system is on.</li> <li>● Green light blinking: System on and the stop button has been pressed.</li> <li>● Green light flashing: APO emergency operation time running.</li> <li>● Red light flashing: CAN communication has been lost/ APO override time running</li> </ul>
	<b>Stabiliser system activation</b>	②	<ul style="list-style-type: none"> <li>● Green light on: Stabiliser system active.</li> <li>● Green light flashing: Stabiliser extension is in locked position.</li> </ul>
	<b>OLP Release</b>	③	<ul style="list-style-type: none"> <li>● Red light blinking: OLP Release active (crane, VSL or stabiliser leg)</li> <li>● Green light flashing: Critical error.</li> </ul>
	<b>Manual extensions</b>	④	<ul style="list-style-type: none"> <li>● Green light on: Manual extension mode is active.</li> </ul>
	<b>Remote control</b>	⑤	<ul style="list-style-type: none"> <li>● Green light on: Remote control is active.</li> <li>● Green light flashing: Button for remote control has been pressed, waiting for connection to hand unit.</li> <li>● Red light on: Radio interference.</li> </ul>
	<b>Parking control</b>	⑥	<ul style="list-style-type: none"> <li>● Blue light on: Slew is in parking position.</li> </ul>
	<b>Service</b>	⑦	<ul style="list-style-type: none"> <li>● Green light on: Service needed.</li> <li>● Red light on: Error in the system.</li> <li>● Red light blinking: Critical error.</li> </ul>
	<b>Dump valve</b>	⑧	<ul style="list-style-type: none"> <li>● Blue light on: Dump activated.</li> </ul>
	<b>ADC</b>	⑨	<ul style="list-style-type: none"> <li>● Blue light on: Crane has enhanced capacity (ADC mode).</li> </ul>
	<b>Hoist</b>	⑩	<ul style="list-style-type: none"> <li>● Green light on: Hoist mode.</li> <li>● Red light flashing: 90% of OLP pressure.</li> <li>● Red light on: 100% of OLP pressure.</li> </ul>
	<b>JDC</b>	⑪	<ul style="list-style-type: none"> <li>● Blue light on: Outermost extension fully retracted and the JIB has increased capacity (JDC mode).</li> </ul>
	<b>VSL-OLP</b>	⑫	Not active in this configuration.
	<b>Stabiliser legs</b>	⑬	Not active in this configuration.
	<b>Stability sector</b>	⑭	<ul style="list-style-type: none"> <li>● Green light on: regardless of the situation.</li> </ul>



	Cylinder pressure	⑮	<ul style="list-style-type: none"> <li>● 1 of 4 green light on: 50% pressure.</li> <li>● 2 of 4 green light on: 70% pressure.</li> <li>● 3 of 4 red blinking light: 90% pressure.</li> <li>● 4 of 4 red light on: 100% pressure.</li> <li>● 4 of 4 red running light: OLP release activated.</li> </ul>
--	-------------------	---	---

**LED test for the user panel, see Daily inspection.**

## 4.8 Dump valves

### Dump valve 1. ①

Allows operation of the crane functions. To prevent high pressure and thereby unnecessary heating of the oil there is an automatic dumping function. When no lever movement has been made for 3 seconds SPACE system opens the dump valve and the oil is returned directly to the hydraulic tank. As soon as the operator moves a lever the valve closes.

### Dump valve 2. ②

Allows operation of the stabiliser extensions and legs only when this valve is activated. The dump valve 2 will be placed between the main control valve and the stabiliser control valve. The dump valve 2 must be activated from the SPACE interface before the stabiliser system can be controlled.

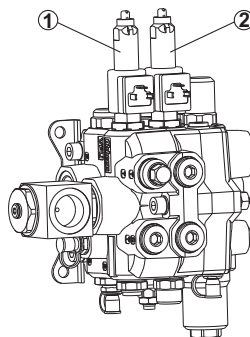

## 4.9 Pressure-reducer filter

Pressure-reducer filter integrated in the main control valve and in the supply valve [option]. The oil goes through the filter and then to the positioner(s).

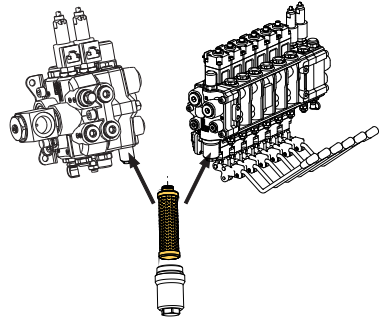

## 4.10 Lamp pole [option]

The lamp pole is equipped with 3 lamps. Flashing/light up: green, amber and red.

- green: start up remote control
- amber: prewarning OLP
- amber and red: OLP



## 4.11 XSDrive controller

Controller XSDrive has either four or six levers, or two or three joysticks for proportional functions programmed in the different menu selections. The controller normally communicates with the crane via radio but can also be operated via cable.



### Radio communication is dependent on:

- Transmitter, fitted in the controller.
- Receiver box, fitted on the operating base.

The Receiver box consists of a combined radio receiver and 12 outputs for servo valves. The status of the receiver is visible on the controller. In case of radio interference, it is possible to change the channel by pushing button . There is a maximum of 12 channels available.



**WARNING**

When the controller is in use (stop button released), keep a distance of minimum 1 meter between the controller and the crane or truck because of possible electromagnetic interference.

**Cable connection [option]**

The cable ② is intended to be used for short-term operation and when pairing in conjunction with the replacement of controller or receiver. Connection is made between the controller ③ and the receiver box ①. Radio communication is automatically disabled when the cable is connected.

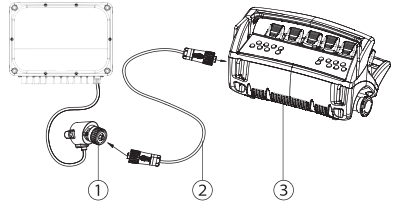

**4.11.1 Indicator LEDs on XSDrive controller**

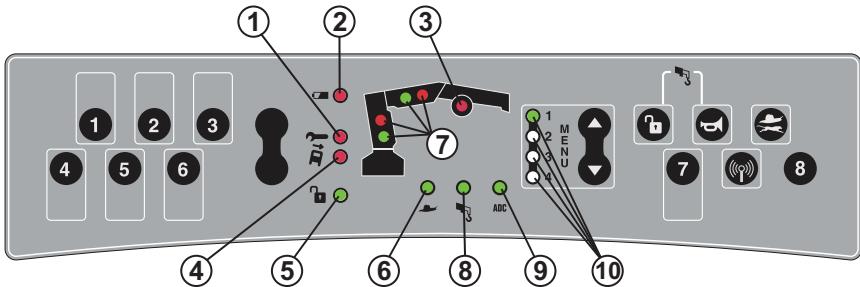

The indicator LEDs on the controller indicates button positions, errors, stability, cylinder pressure etc. The appearance of the panel differs somewhat depending on if the controller has levers or joysticks.



	<b>Service</b>	①	● Red light on: Error detected in the system.
	<b>Battery</b>	②	● Red light on: Low power
	<b>Hoist LED</b>	③	● Red light flashing: 90% of maximum pressure ● Red light on: 100% of maximum pressure
	<b>VSL</b>	④	Not active in this configuration.

## 4.11.2

## The HiPro system

	<b>OLP Release</b>	⑤	<ul style="list-style-type: none"> <li>● Red light on: OLP</li> <li>● Red light blinking: OLP Release.</li> </ul>
	<b>Low speed</b>	⑥	<ul style="list-style-type: none"> <li>● Green light on: Reduced speed. For normal speed, see section "Buttons"</li> </ul>
	<b>Cylinder pressure LEDs</b>	⑦	<ul style="list-style-type: none"> <li>● Lower LEDs green light on: 70% of maximum pressure</li> <li>● Lower LEDs, red light flashing: 90% of maximum pressure</li> <li>● Lower and upper LEDs red light: 100% of maximum pressure</li> </ul>
	<b>Manual extension</b>	⑧	<ul style="list-style-type: none"> <li>● Green light on: Manual extension activated</li> </ul>
<b>ADC</b>	<b>ADC</b>	⑨	<ul style="list-style-type: none"> <li>● Green light on: Increased capacity (ADC mode)</li> </ul>
	<b>Menu LEDs</b>	⑩	<ul style="list-style-type: none"> <li>● Light on: Indicates active menu</li> </ul>

### 4.11.2 Buttons

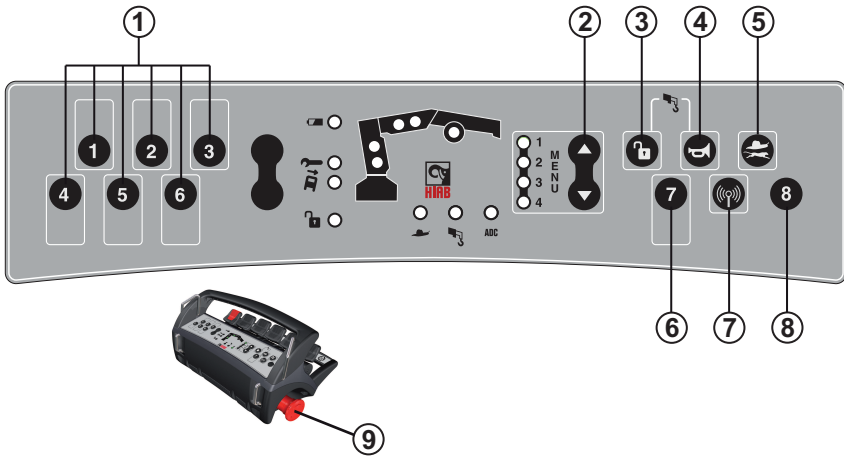

①	<b>ON/OFF buttons</b>	Buttons for 7 extra ON/OFF functions (engine on/off, engine speed, horn etc.)
②	<b>Menu selection</b>	Push to change between menus 1 to 4.
③	<b>OLP release</b>	Push and hold the button while you operate a pressure reducing function.
④	<b>Horn</b>	Push to operate the horn.

③ & ④	<b>Manual extensions</b>	Push at the same time to activate the manual extension.
⑤	<b>Speed selection</b>	At the start, you have maximum operational speed. Push the button to operate the crane with decreased speed. Push it again for maximum speed.
⑥ & ⑧	<b>LSS-V</b>	If the crane has LSS-V, button ⑥ activates this feature and button ⑧ deactivates it.
⑦	<b>Channel shift</b>	Push to change radio channel. There are 12 channels in total.
⑨	<b>Stop button</b>	When you push the button, you stop all crane functions. To release it, turn the button clockwise.

### Locking the controller

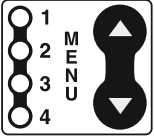
	<ol style="list-style-type: none"> <li>1. Push the stop button.</li> <li>2. Push and hold both arrows on the toggle button and release the stop button at the same time.</li> <li>3. The 4 LEDs flash at the same time. Now you cannot operate the controller.</li> <li>4. Push the stop button.</li> </ol>
---	---

### Unlocking the controller

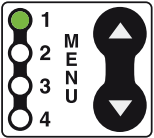
	<ol style="list-style-type: none"> <li>1. Make sure that you pushed the stop button.</li> <li>2. Push and hold both arrows on the toggle button and release the stop button at the same time.</li> <li>3. The 4 LEDs flash at the same time for 5 times.</li> <li>4. LED 1 comes on. (Start menu)</li> </ol>
---	--





## 4.11.3 Menus

The functions presented in each menu can be customized depending on crane configuration. It can be changed by a Hiab Authorized Workshop.

The table below shows an example:

### 4.11.3

## The HiPro system

<b>Menu 1</b> 	Slewing, first boom, second boom, extension boom, tools JIB, hoist, etc.
<b>Menu 2</b> 	[option] (If crane is equipped with extra remote controlled stabiliser system)
<b>Menu 3</b> 	[option] Slewing, attachment. (If crane is equipped with remote controlled stabiliser): left and right stabiliser extension, left and right stabiliser leg.
<b>Menu 4</b> 	[option] Similar to menu 3 but for extra stabiliser legs

### 4.11.4 Standard functions and symbols

The function corresponding to each lever depends on the configuration of the specific crane. The table below shows examples:

Controller XSDrive levers

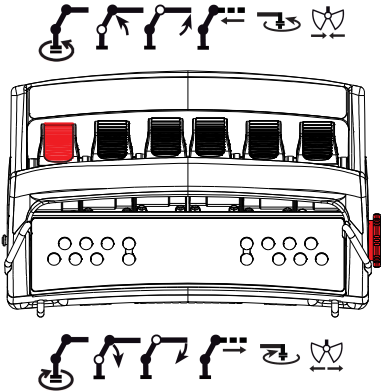

Controller XSDrive joystick 3-0-3

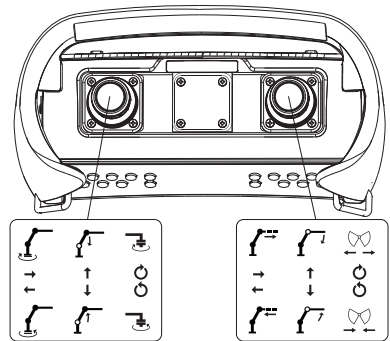

Controller XSDrive joystick 2-2-2

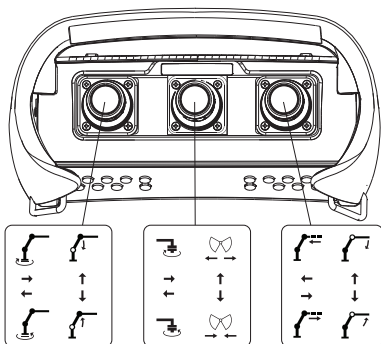

Controller XSDrive joystick 3-2-3

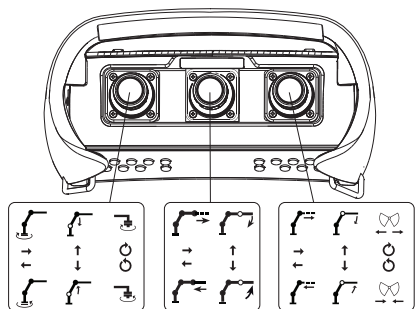

## 4.11.5 Battery and battery charger

### XSDrive

#### Battery

A fully charged battery provides approximately 5-8 hours use (at 25 °C, 77 °F) and the voltage level is approximately 8,4V. When the battery is about to wear out an indicator LED on the controller burns steady red and the horn will sound twice. Push the stop button before changing the battery. Note that the battery voltage remains between 7,6V and 7,5V for a long time. Therefore, the battery voltage cannot be used to estimate remaining hours of use.

#### Battery charger

The battery charger is to be fitted in a protected environment, preferably in the cab. Two batteries are delivered with each unit, one of which can always be placed in the charger.

LED ① is lit continuously when the battery charger is ready for use. Place the battery in the charger. LED ② flashes slowly during recharging and has a steady light when the battery is fully charged.

#### Charging time

The normal charging time for a flat battery, is approximately 3 hours. Operating ambient temp: Battery = 0° to + 45°C.



#### ! NOTE

A charged battery is a concentrated energy source. Never store a charged battery in a toolbox or similar, where there is a risk of a short due to contact with metal components. Used batteries should be taken care of according to the local regulations.

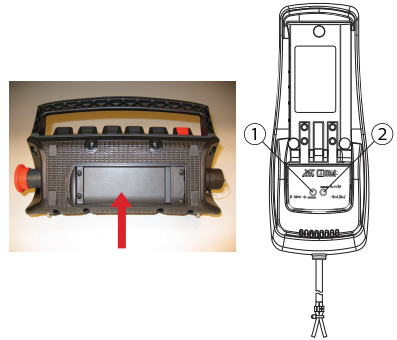



## 4.12 CombiDrive controller

The controller has either six or eight levers. Normally the controller operates wirelessly via radio but it can also be operated via cable. The controller is equipped with a menu selection system as standard. The displays continuously provide the operator with information.

### Radio communication is dependent on:

- Radio for two-way communication fitted in the controller.
- Radio/decoder fitted at the crane base.

Information can be sent both from and to the controller. In the decoder/radio there is a corresponding unit which handles the traffic at the other end.



### Cable connection:

A four-metre cable is supplied as standard with The controller. The cable is intended to be used for short-term operation and when pairing in conjunction with the replacement of controller or decoder. The cable connects to the vehicle at the connector ① on the front of the decoder.

When the cable is connected to the controller ②, the centre display shows the symbol for cable operation.



### 4.12.1 Displays

The displays are of LCD-type and will perform best in temperatures above +10 °C. At 0 °C there is a delay in shifting symbols of approximately 1 sec. At -20 °C the delay will increase to approximately 8 sec. Alternating symbols will not be updated at temperatures below freezing.

In order to prevent inaccurate menu shifts, in temperatures below -10 °C there will be a delay before any menu button will react to a second press. This can partly be avoided by storing the controller in a compartment where the temperature exceeds +10 °C whenever not in use.



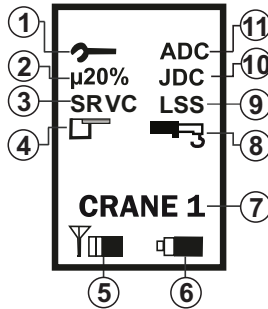

#### Centre display

The center display provides information about which menu has been chosen, as well as indicating for example radio reception, battery status, fault information, ADC and VSL.

#### Indications on the centre display



	<p><b>① Error</b> This symbol, a spanner, appears if the control system, has discovered a fault in the system. See section “Buttons” for error code display. Non critical error: Symbol appears enlarged in the center of the display and then returns to normal size in the upper part of the display. Critical error: Symbol remains enlarged in the center of the display. The crane stops.</p>	<p><b>⑦ Main menu</b> The text shows which main menu has been selected. The number shows which sub-menu is active. The main menus are CRANE, EXTRA and ON-OFF.</p>	<p>CRANE 1 EXTRA 2 ON-OFF 2</p>
---	--	--	---

	<p>② <b>Micro</b> Indicates that micro operation has been selected. Micro operation changes the sensitivity of the levers as follows: At full lever deflection, <math>\mu 50\%</math> gives 50% and <math>\mu 20\%</math> gives 20% of normal speed.</p>	<p>⑧ <b>Manual extension</b> Manual extension is selected by pressing the horn and release buttons at the same time. The control system acknowledges by showing this symbol.</p>	
<p>SRVC</p>	<p>③ <b>SRVC</b> Indicates time for service. When remote control is first engaged, the symbol will be shown enlarged and then return to normal size.</p>	<p>⑨ <b>LSS (Load Stabilizing System)</b> Indicates that the LSS-V function is active.</p>	<p><b>LSS</b></p>
	<p>④ <b>MEWP (Mobile Elevating Work Platform)</b> Indicates that MEWP mode (if present) is active.</p>	<p>⑩ <b>JDC</b> Indicates that the JDC function is active.</p>	<p><b>JDC</b></p>
	<p>⑤ <b>Signal strength</b> The bars show the radio signal strength. Five bars indicate optimum reception. If the symbol flashes, the radio is connected but starting conditions are not met.</p>	<p>⑪ <b>ADC (Automatic Duty Control)</b> Indicates that the ADC function is active.</p>	<p><b>ADC</b></p>
	<p>⑥ <b>Battery capacity</b> The battery symbol shows remaining power in the battery. When the symbol begins to flash there is capacity for just a few more minutes. When this happens the horn on the crane will sound twice as an indication of low battery.</p>		

**Left and right displays**

The side displays show the symbol for the function which each lever controls in the active menu. Function symbols change according to which menu has been activated. The direction shown in the function symbols applies to when the lever is moved forward.

4.12.2 Buttons

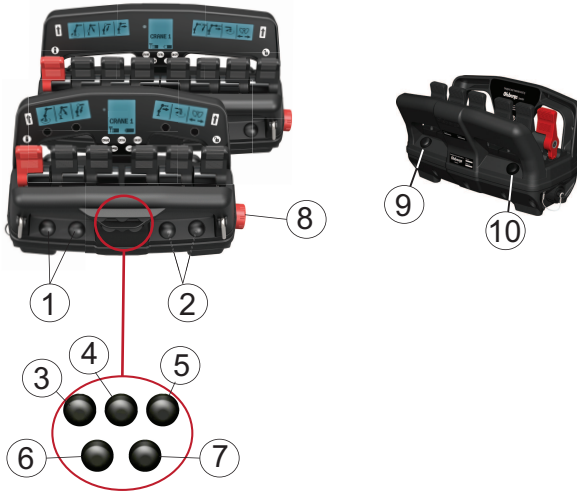

①②	<p><b>ON/OFF buttons [option]</b> The controller has four configurable pushbuttons for controlling on/off functions e.g. start/stop engine, increase/decrease rpm on the engine etc. The function of each button is depending on the configuration of the specific crane.</p>	<p><b>Micro mode</b> Push to choose micro mode. Push again to choose normal mode.</p>	⑦
③	<p><b>Menu CRANE</b> Push to choose menu CRANE.</p>	<p><b>Stop button</b> Push to deactivate the controller. Release to activate.</p>	⑧
④	<p><b>Menu EXTRA</b> Push to choose menu EXTRA.</p>	<p><b>OLP release</b> Push and hold to activate OLP release. See section “OLP release”.</p>	⑨
⑤	<p><b>Menu ON-OFF</b> Push to choose menu ON-OFF.</p>	<p><b>Manual extensions</b> Push simultaneously to activate OLP for manual extensions.</p>	⑥&⑨

④&⑤	<b>Locking of controller</b> See section “Locking and unlocking the controller”.	<b>Error code display</b> Push the button to display error codes in the system. If there are more than six error codes at the same time, the six most recent ones sent from the control system, are shown.	⑩
⑥	<b>Horn</b> Push to sound the horn.		

## Locking and unlocking the controller

### Locking the controller

1. Push and hold button ④ and ⑤ while the stop button is pushed.
2. Keep button ④ and ⑤ pushed while pulling out the stop button. The centre display then shows a large locked padlock symbol .

### Unlocking the controller

1. Push and hold button ④ and ⑤ while the stop button is pushed.
2. Keep button ④ and ⑤ pushed while pulling out the stop button.
3. Release button ④ and ⑤.

The controller is ready to use.



### 4.12.3 Menus, standard functions and symbols

The function of each lever may be the same or different in different menus. The left and right displays show which function is controlled by each lever. The function symbols show a direction (up, down, left, right) which applies to when the lever is moved forwards.

#### Main menus:

- CRANE menu, button ③
- EXTRA menu, button ④
- ON-OFF menu, button ⑤

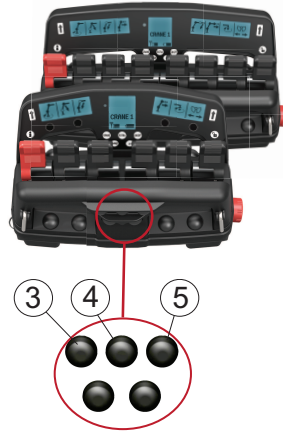

In each of the main menus the operator can step through submenus by pushing the menu button repeatedly.

Each function is operated using a specific lever. If a lever is faulty or moved at startup, the lever and the function is disabled. The other levers works as normal. With the 2 extra levers on the 8 lever controller, it is possible to use the seventh and eighth functions simultaneously with functions 1-6, without shifting CRANE menu.



#### CRANE menu, button ③

When the operator pulls out the stop button on the controller, it always starts in CRANE 1 menu. The submenus in CRANE menu are configured in production but can be changed by HIAB service personnel.

Example of submenus for the 6 lever controller:

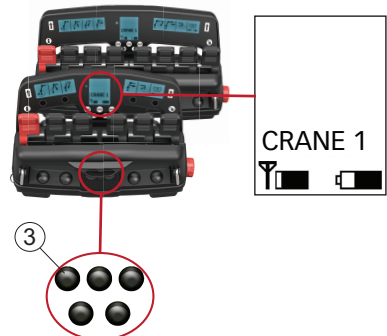

	Left side display			Centre display	Right side display		
	<p>"CRANE MENU"</p>				<p>CRANE 3</p>		
				<p>CRANE 2</p>			
				<p>CRANE 1</p>			

Example of submenus for the 8 lever controller:

"CRANE MENU"	Left side display				Centre display	Right side display			
	3						CRANE 2 		
2									
1					CRANE 1 				

**EXTRA menu, button ④**

The EXTRA menu contains hydraulically proportional functions for example front and rear stabiliser extensions and legs, boat supports, bunk shifting, etc

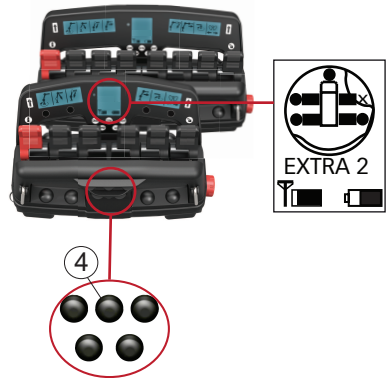



## Symbols shown on the displays

The order of the levers is customized.

- Crane stabiliser leg ① down/up.
- Crane stabiliser leg ② down/up.
- Auxiliary stabiliser leg ③ down/up.
- Auxiliary stabiliser leg ④ down/up.
- Crane stabiliser extension ⑤ out/in.
- Crane stabiliser extension ⑥ out/in.
- Auxiliary stabiliser extension ⑦ out/in.
- Auxiliary stabiliser extension ⑧ out/in.

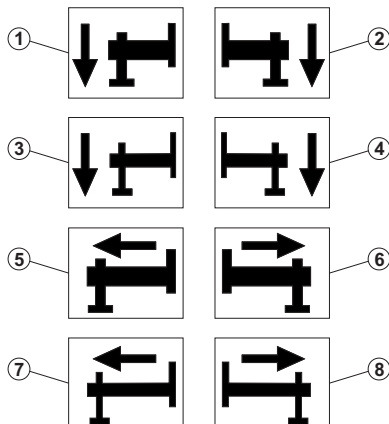

## ON-OFF menu, button ⑤

The ON-OFF menu includes functions such as engine start, stop and throttle. The functions are shown as text instead of symbols in the displays. A lever may be moved in any direction in order to activate the corresponding function.

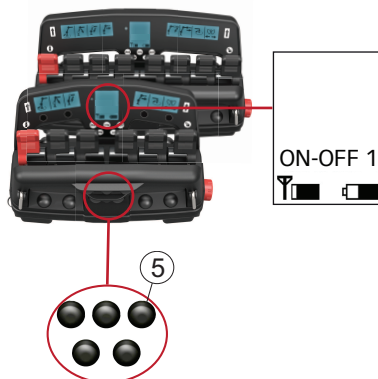

Examples of the left side display		Centre display	Examples of the right side display	
FRONT LIGHT	REAR LIGHT	ON-OFF 2 Y ■ ■	PUMP 1	PUMP 2
ENGINE START	ENGINE STOP	ON-OFF 1 Y ■ ■	ENGINE RPM UP	ENGINE RPM DOWN

## 4.12.4 Battery and battery charger

### Battery

The voltage level of a fully charged battery is approximately 8,4V and it provides about 5-8 hours working time. Note that the battery voltage remains between 7,6V and 7,5V for a long time. Therefore, the battery voltage cannot be used to estimate remaining hours of use.

Install a fully-charged battery in the controller as shown on the right. It is important to fit the battery the right way round. If the battery is upside-down the controller will not start.



### Battery charger

The battery charger is to be fitted in a protected environment, preferably in the cab. Two batteries are delivered with each unit, one of which can always be placed in the charger.

Normal charging time for a flat battery, is approximately 3 hours. Operating ambient temp: Battery = 0° to + 45°C.

### Display A

- ① lights when the charger is activated.
- ① and ② lights during charging.
- ① and ③ lights when the battery is fully charged.

### Display B

Shows the battery voltage (8.4).

When the display blinks 0.0 there is error in the battery: Change battery.

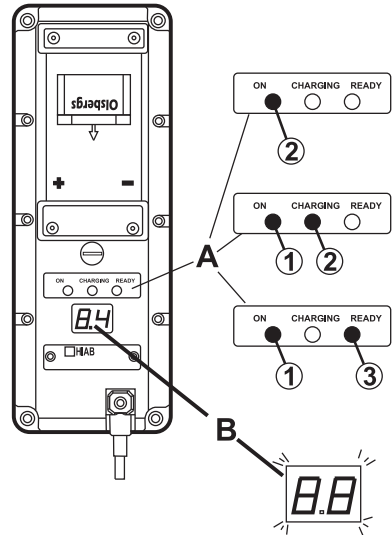

### ! NOTE

A charged battery is a concentrated energy source. Never store a charged battery in a toolbox or similar, where there is a risk of a short due to metal components. Used batteries should be taken care of according to the local regulations.

## 5.1 Starting operations [AR+]

- **General case:**

Place the vehicle on a flat, firm and stable surface. The vehicle inclination ( $\alpha$ ) during crane operation must **not be more than 3°**. If this value is exceeded, unintentional crane movements can occur.

To determine the inclination of the truck, check the spirit level on the crane. When the bubble is in the middle of the gauge, the crane is in horizontal position. When the bubble is between the two circles, the crane inclination is between 0° and 5°.

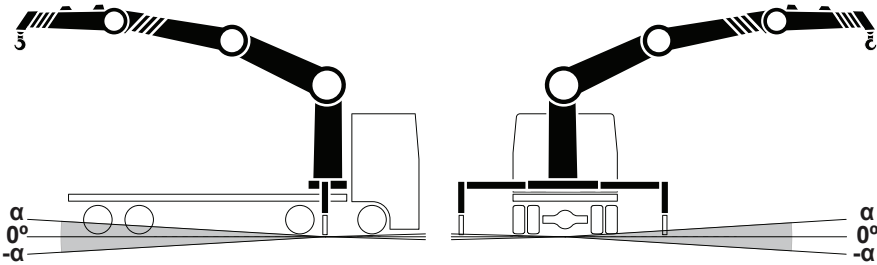
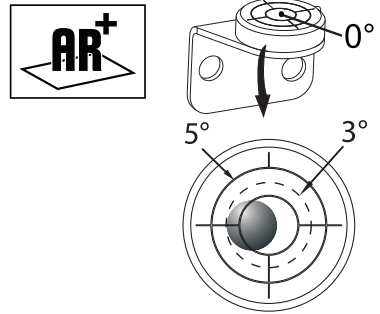

- **Working with boom system beyond 60°**

To avoid side deflection and in order to guarantee the safest operation when working with e.g. Lifting Accessories and/or Hoist applications and/or JIB/MEWP applications, the vehicle has to be completely levelled in any direction ( $\alpha=0^\circ$ ).



### ! NOTE

- Operating the crane in to and out of transport position must also be done with the vehicle completely levelled.
- Activate the parking brake and place chocks under the wheels to prevent vehicle movement.

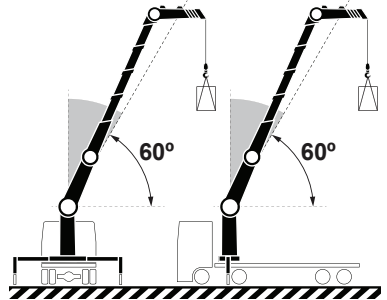

### Engage the PTO

Engage the PTO (Power Take Off) and bring the vehicle engine to the correct rpm.



#### ! NOTE

- Rpm too high: the oil in the hydraulic system might overheat. Rpm too low: during crane operation, the vehicle engine could stall.
- The maximum rpm may depend upon a governor on your PTO combination.

### Start the control system

The operating levers must be in neutral position before start up. To start the control system, press the On/Off button  on the user panel.

The LED above the button starts to lights up. The system will check itself (2-4 seconds).

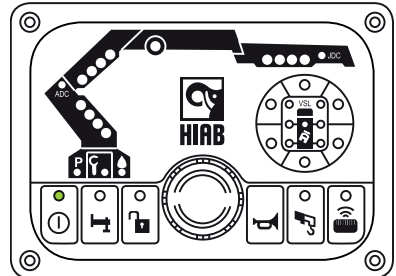

### Start the controller

1. Fasten the controller to a waist belt, or shoulder-neck strap, in the most comfortable operation position. The Stop button should be on the right hand side.
2. Press the button . The LED above that button gives a steady light.
3. To activate the controller, pull out the stop button by turning it clockwise.

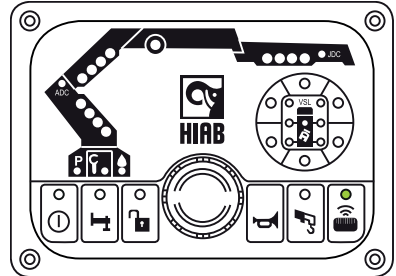

### Indications XSDrive

The menu LEDs on the controller starts blinking. When communication has been established, the LEDs will give a steady light = ready for use.



### Indications CombiDrive

“Wait” is shown on the centre display while radio contact is being established. On the decoder LED ① is lit. LED ② starts to blink.

When contact has been established CRANE 1 menu and signal strength are displayed on the controller. On the decoder LED ② on gives a steady light and LED ① flickers.

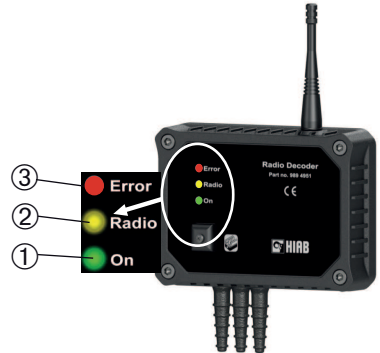

## 5.2 Set the stabiliser system

To ensure the maximum stability of the vehicle, all the stabiliser extensions and legs must be fully extended and set to the ground without lifting the wheels from the ground.

- **Cranes with VSL:** when the stabiliser extensions are not fully extended, the lifting capacity is optimized by the VSL function to ensure the maximum stability of the vehicle.
- **Cranes without VSL:** crane must be operated with the stabiliser extensions fully extended and the stabiliser legs set to the ground without lifting the wheels from the ground, otherwise the stability of the vehicle will not be ensured.

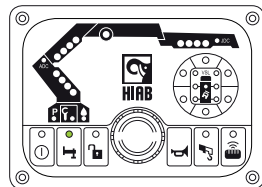

### DANGER

For cranes without VSL the operator is responsible to make sure that the vehicle is stable while lifting a load and the maximum load is not exceeded.

**Stability sector indication**

The operator must have a full view of the stabiliser system when operating it. To confirm a full view of the stabiliser system, button  is pushed on the user panel on the side where the stabiliser system is going to be operated. As soon as the button has been pushed, the LED for the active stabiliser leg will light green.

- **Cranes with VSL:** the stability sector LEDs will indicate the crane capacity in six different sectors due to stability. The stability sector indication will change according to the stabiliser system position.
- **Cranes without VSL:** the stability sector LEDs will light green regardless of the situation. The operator is the responsible to make sure that the vehicle is stable while lifting a load.

**5.2.1 Stabiliser system and ground conditions**

**Always:**

- Make sure that the ground can support the load that the stabiliser leg imposes on the ground. (\*)
- Make sure that the ground is not undermined.
- Use the extra support plates that are large and firm enough for your crane model.

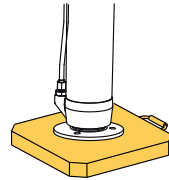

**The maximum permitted ground inclination under the stabiliser leg plate is 5°.**

**(\*) The maximum load that the stabiliser leg can impose on the ground:**

Crane Model	P (KN)	Crane Model	P (KN)
265-285	108	358-398-408-418	236
410K	164	528-548-558-638-658	247
322-377-328-352-362-388	224	858-1058	368
422-477-395-425-335K-435K	230	Auxiliary stabilisers	205





**DANGER**

Check that the extra support plates do not bend or sink into the ground.



Do not lower the stabiliser legs on the edge of an embankment, soft ground, hollows, etc... Lower the stabiliser legs only on to a flat, firm and stable surface.

### 5.2.2 Activate the stabiliser system

#### Manually controlled stabiliser system:

1. Make sure manual control is active. If not, push the button  on the user panel
2. Push the button  to activate stabiliser system operation.

#### Remote controlled stabiliser system:

1. Make sure remote control is active. If not, push the button  on the user panel.
2. Select the menu for stabiliser system on the controller.
3. On the side where the stabiliser extensions are to be operated outwards, push the button  to activate stabiliser system operation and confirm the view. The stabiliser legs can be driven up and down regardless of the side.

### 5.2.3 Extend the stabiliser extensions

The procedure of setting the stabiliser extensions differs depending on the type of stabiliser extensions. Repeat the instructions for the stabiliser extension on the other side of the vehicle. For auxiliary stabiliser system [option]: Repeat the process.



**Hydraulically controlled stabiliser extensions**

Unlock the Stabiliser locking device ② [option] and extend the stabiliser extensions with the levers on the valve or the controller depending on your crane configuration.

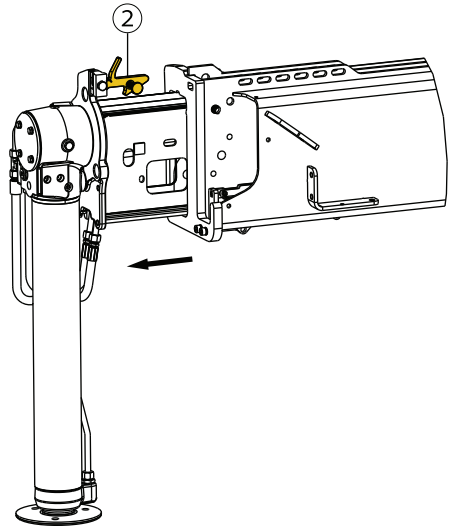
**DANGER**

Do not stand in front of the hydraulically operated stabiliser legs when you are operating them!

**5.2.4 Set the stabiliser legs [AR+]**

The procedure of setting the stabiliser system differs depending on the type of stabiliser system. Repeat the instructions for the stabiliser extension and leg on the other side of the vehicle. For auxiliary stabiliser system [option]: Repeat the process.

**WARNING**

Take care not to lower the stabiliser leg onto your foot.



**! NOTE**

For cranes with VSL the stabiliser leg downward movement is automatically stopped at a pre-given force level. To exceed this pre-given force level, operate the stabiliser leg down once again.

**DANGER**

Always ensure that the stabiliser legs and stabiliser extensions are in working position and securely locked.

**Place the extra support plates**

- Place the extra support plates under the stabiliser leg plates.

**DANGER**

Check that the support plates do not bend or sink into the ground!

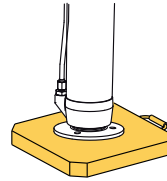
**Non-tiltable stabiliser legs**

1. Make sure that the stabiliser extensions are extended.
2. Operate the stabiliser leg downwards until it is set to the ground.

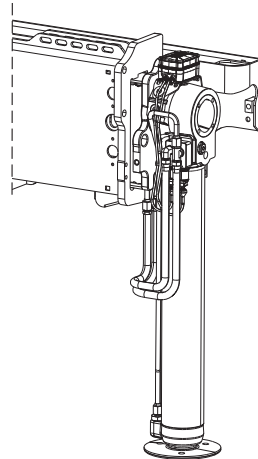

**Manual tiltable stabiliser legs**

1. Make sure the stabiliser extensions are extended a little.
2. Unlock the stabiliser leg lock ②, that holds the stabiliser leg in the transport position.

**DANGER**

**Do not stand in the stabiliser leg tilting area.**

3. Tilt the stabiliser leg downward.
4. Lock the stabiliser leg lock ②.
5. Extend the stabiliser extension. For manual extensions, lock the extension.
6. Operate the stabiliser leg downwards until it is set to the ground.

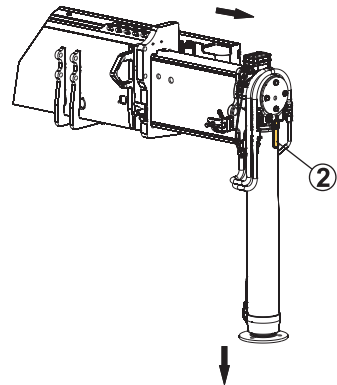
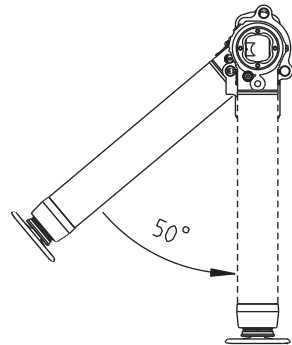
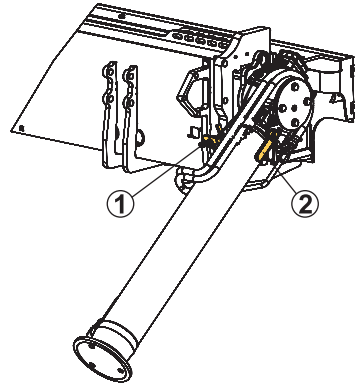

### Manually tiltable stabiliser legs with gas spring support

1. Make sure the stabiliser extension is extended and the stabiliser leg can rotate freely of the vehicle.
2. Place your right hand on the handle ③ while unlocking the stabiliser leg ④ with your left hand. Make sure the leg drops in a controlled movement until it stops. Push the handle until the leg is pointing downwards.

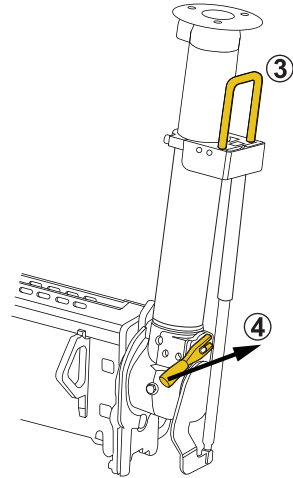

#### DANGER

Do not stand in the stabiliser leg tilting area.

3. Lock the stabiliser leg with the handle ④.
4. Extend the stabiliser extension. For manual extensions, lock the extension.
5. Operate the stabiliser leg downwards until it is set to the ground.

### Mechanically controlled tiltable stabiliser legs [AR+]

1. Make sure the stabiliser extension is extended a little and the stabiliser leg can be rotated freely of the vehicle.
2. Unlock the stabiliser leg lock ①.
3. Use the stabiliser leg lever to tilt the stabiliser leg. Make sure that you have full control of the movement to avoid risk of crushing.

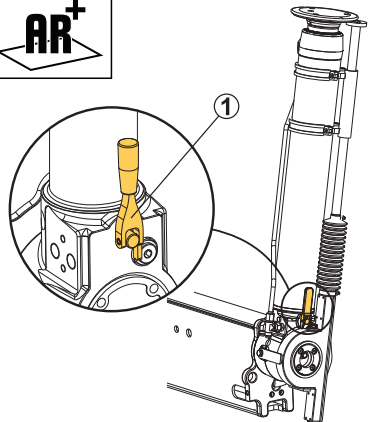

#### DANGER

Do not stand in the stabiliser leg tilting area.

4. Lock the stabiliser leg lock ①.
5. Extend the stabiliser extension. For manual extensions, lock the extension.
6. Operate the stabiliser leg downwards until it is set to the ground.

---

### 5.3 Operate the boom system out of transport position



#### WARNING

- A crane with add-on equipment can differ from the operations described in this section. For this reason, study the operating instructions for any add-on equipment carefully.
- Always ensure that the stabiliser extensions and legs are in working position and securely locked before operating the boom system out of parking position.

**DANGER**

Always operate a manually controlled crane from the position shown in the image!



1. If the stabiliser system is manually controlled, push button  on the user panel to activate remote control.
2. If using remote control, push button ① on the controller to change the menu into crane operation.

**! NOTE**

As soon as you have selected remote control operation, it is no longer possible to operate the main control valve levers.

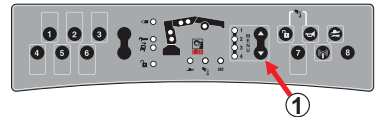
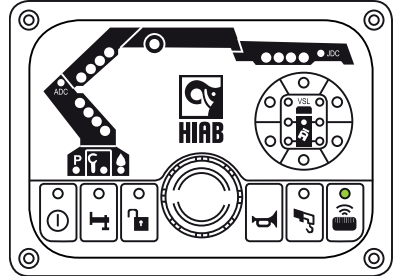

### 5.3.1 BDA Boom Deployment Assistance [AR+]

BDA is a safety function in SPACE that prevents the operator to move the second boom and extensions in the wrong direction when operating the crane in to or out of parking position.

- Operating the crane to parking position:

When the angle  $\beta$  is  $>135^\circ$  between the horizontal and second boom, the system doesn't allow to raise the second boom or to move extensions out/in.

Press the button for release to allow second boom and extensions movements.



#### DANGER

Only use the BDA override to get the crane out of a locked position.

- Operating the crane out of parked position:

When the angle  $\beta$  is  $<135^\circ$  between the horizontal and second boom, second boom and extensions can move without any restrictions.

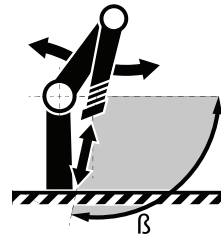
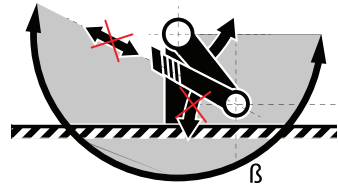
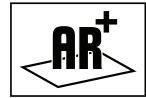

## Operate the boom system

## • HIAB 358 / 408 / 418:

1. Turn the pin and pull it out ①.
2. Raise the first boom ② until BDA allows you to operate the second boom or  $\beta > 135^\circ$ .
3. Check that the parking pin "A" is in the correct position. There should be no contact between the tip of the pin "A" and the parking support "B", as shown in ③. If needed, move the second boom against the first boom slowly.

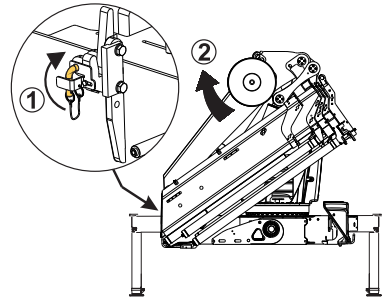

**CAUTION**

Take care not to damage the parking pin and parking support during these operations.

4. Extend the first extension ④ until parking pin "A" comes free of the parking support "B" and plate "C" is shown.
5. Raise the second boom ⑤.

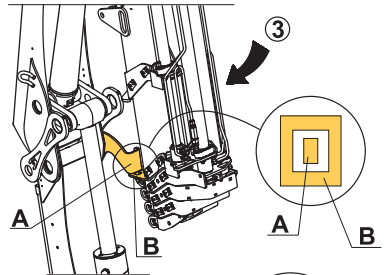

**CAUTION**

Pay careful attention not to damage the slewing motors.

6. Slew the crane to the working position. The crane is now ready for use.

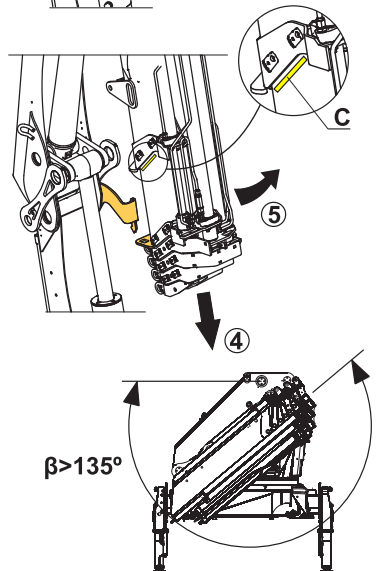



## 6.1 Functions

The control system provides a large number of functions. Certain functions are standard, others are options.

### 6.1.1 Controlling the crane speed with the controller XSDrive

At start up, the system by default is set to full speed. To reduce the speed, push button  once. The low speed LED will light continuously. By pushing the button again, the crane returns to full speed and the LED goes out.

When pushing the speed selector button, all levers must be in neutral.

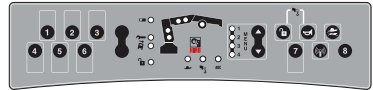

#### ! NOTE

The crane speed will depend upon the crane functions you are using and how many crane functions you operate at the same time.

### 6.1.2 Controlling the crane speed with the controller CombiDrive

At startup the crane speed is set to 100%. It is possible to choose between three different speeds. Push button  to change. Current speed is shown as a percentage on the display.



### 6.1.3 Supervision of spools

If a valve spool movement is greater than the equivalent lever or joystick movement on the controller, a safety function is tripped, and all crane movements stops.

This occurs if a control lever on the valve is moved while the remote control is engaged.

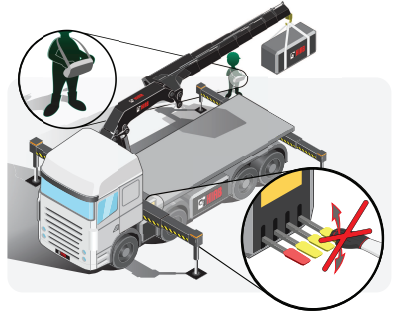

### 6.1.4 APO Automatic power off

APO is a function which automatically switches off the power to the control system. It consists of:

1. Timeout controlled power off. (30 minutes by default).
2. Parking brake controlled power off.

Through the vehicle's parking brake, APO offers a safety function which ensures that the control system is off when the vehicle is moving. When parking brake is released, the control system receives a signal and shuts OFF.

#### For emergency operation

During 5 seconds, it is possible to activate the control system by pushing the ON/OFF button on the user panel.

### 6.1.5 ADO Automatic dump function

If a lever is not moved for 3 seconds, this function diverts the oil to the tank, thereby preventing the oil from overheating. The next lever movement stops the dumping and it functions as normal.

### 6.1.6 ASC Automatic Speed Control

The ASC function automatically provides the extra power by reducing the speed smoothly, when working close to the rated capacity. When the load decreases, normal speed is restored.

### 6.1.7 ADC Automatic Duty Control

The purpose of the ADC function is to increase the lifting capacity by 10%.

The first boom pressure sensors indicate if there is a positive or negative pressure on the first boom.

#### Normal capacity

- If the first boom is pressed down, the sensors indicate a negative pressure and the lifting capacity is normal during the complete lifting cycle.

#### Increased capacity (ADC mode)

- ADC lamps light up.  
If the sensors indicate a positive pressure, the lifting capacity is increased during the complete lifting cycle.

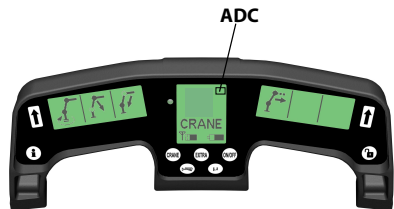
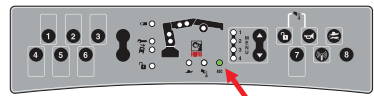
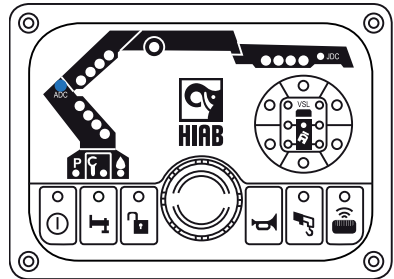

### 6.1.8 PFD Pump flow distribution

When operating several functions simultaneously the pump flow may not be sufficient. PFD will now take over, reducing the speed of all operated functions. Uncontrolled movements are thus avoided, smooth simultaneous operation is achieved.

### 6.1.9 Slewing sector [option]

Within slewing sector, lifting capacity can be reduced due to stability. The overload warning will be given at a lower load in the limited sector than outside the sector. In case of an overload warning you may slew out of the sector but not further into it.

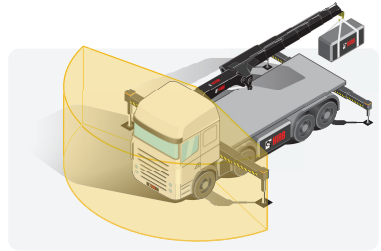

### 6.1.10 LSS-V Load stabilising system-vertical [Option]

LSS-V reduces vertical oscillations in the boom system. This function makes it easier to handle loads at long outreach.



#### WARNING

Deactivate LSS-V when working in confined spaces. Compensating movement can cause the crane to collide with obstacles.

If the function LSS-V is active when SPACE is switched off, the function will be active when SPACE is started again.

#### Activate and deactivate LSS-V (By default) with the controller XSDrive

Push button ⑥ to activate and button ⑧ to deactivate.

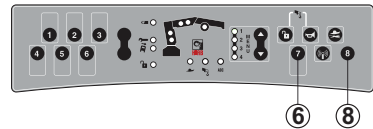

#### Activate and deactivate LSS-V (By default) with the controller CombiDrive

1. Push the ON-OFF button ⑤ on the remote control.

- CombiDrive with 6 levers: Menu 2 ON-OFF
- CombiDrive with 8 levers: Menu 1 ON-OFF

2. Move the levers according to the text in the display.

- CombiDrive with 6 levers: lever 4 (activate) and lever 5 (deactivate).
- CombiDrive with 8 levers: lever 7 (activate) and lever 8 (deactivate).

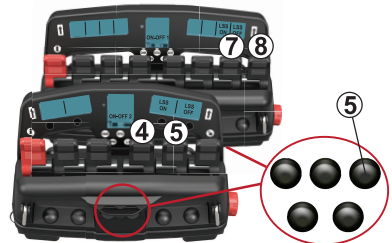

## 6.2 OLP (Overload protection)

OLP is a safety function that prevents overloading of the crane. With 90% of maximum permitted pressure the amber lamp on the lamp pole, if present, flashes.

### OLP boom system

When 100% of the maximum permitted pressure is reached, OLP cuts in and stops all functions that increase the pressure. On the lamp pole, if present, the red lamp and amber lamp will light continuously.

The pressure level in the first and second boom is indicated by the LEDs on the user interface:

- 50% of maximum pressure – 1 of 4 LEDs light green
- 70% of maximum pressure – 2 of 4 LEDs light green
- 90% of maximum pressure – 3 of 4 LEDs flash red
- 100% of maximum pressure – 4 of 4 LEDs flash red



### ! NOTE

Do not operate heavy loads with the extensions fully retracted. In an OLP situation it is an advantage to be able to retract the extensions.

### OLP manual control

If one prohibited function is used, all functions will stop. The crane will be fully operational as long as only allowed functions are used.

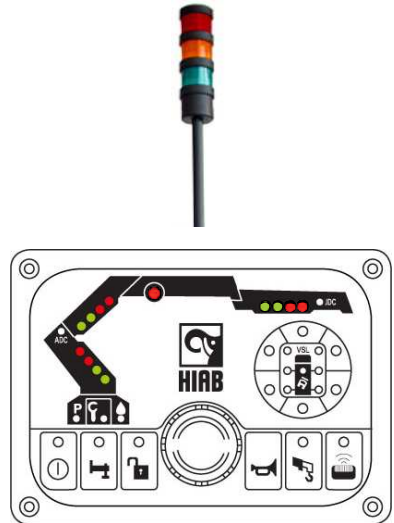

## 6.3 OLP - indications on the controller

### 6.3.1 XSDrive

**OLP boom system:** The cylinder LEDs indicate a percentage of maximum pressure:

- 70% of maximum pressure reached - lower LED on each cylinder light green
- 90% of maximum pressure reached - lower LED on each cylinder flash red
- 100% of maximum pressure reached - both LEDs on each cylinder light red

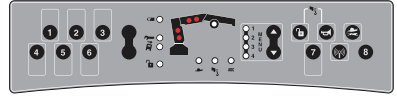

### 6.3.2 CombiDrive

**OLP boom system shown on the left and right displays:**

- A percentage of maximum permitted pressure in the cylinders is shown on the displays. When 50% or more of maximum pressure is reached, the percentage alternates with the function symbol once a second in the display corresponding to each lever. The display shows 50%, 70%, 90% and 100% as the pressure increase.
- When pressure reaches 100 %, all functions that would increase pressure are blocked. If the operator attempts to operate a blocked function, the function symbol is replaced by a cross while the lever is engaged. When the lever is returned to neutral position, the cross disappears and the function symbol returns. Operate permitted (pressure reducing) functions only. In an OLP situation, symbol "x" is shown in every menu in the centre display.

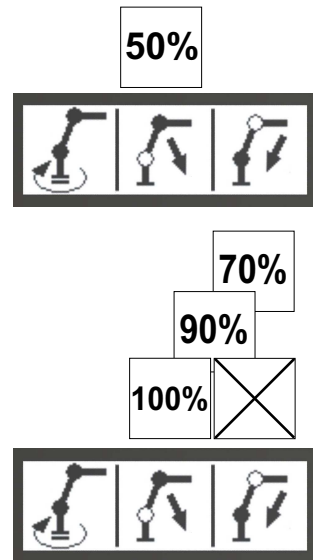

## 6.4 To release OLP

If all functions have been blocked due to OLP it is possible to temporarily release OLP and operate an appropriate crane function to correct the overload situation. OLP release is active in 5 second intervals. After each 5 second interval of OLP release there is a wait before the release operation can be activated again. The wait will increase in three steps: 30, 60 and maximum 90 seconds. During each 5 second interval only one function at a time can be operated. Extension out cannot be operated at all. The 5 second interval starts to count down as you move the lever.



### DANGER

Only use the OLP release to get the crane out of a locked position. Never use the OLP release to overload the crane deliberately!

### OLP release on user panel

Push and hold button  on the user panel whilst operating load reducing functions. The cylinder pressure LEDs on the user panel perform a running light. The LED for padlock symbol will blink red.

### OLP release on controller XSDrive

Push and hold the button  on the controller whilst operating load reducing functions. On the user panel the cylinder pressure LEDs perform a running light. The LED for padlock symbol will blink red.

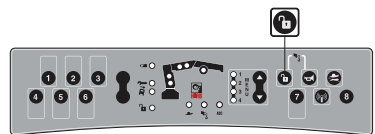
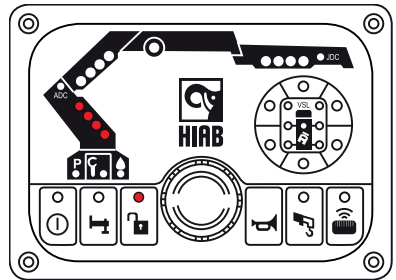

### OLP release on controller CombiDrive

Push and hold the button ⑨ on the right hand side below the display handle. The unlocked padlock will appear in the centre display. On the user panel the cylinder pressure LEDs perform a running light. The LED for padlock symbol will blink red.



## 6.5 Manual extensions [option]

### Operation with manual extensions

- Always extend the hydraulic extensions first, then the manual extensions.
- The use of manual extensions should be restricted to the longest outreach needed. When this reach is not needed, the manual extension should be retracted.



### DANGER

Do not stand in front of moving parts. They may eventually move and cause injuries.

### To extend the manual extensions

1. Locate the boom system as close as possible to the horizontal position, but low enough to reach the extension by hand.
2. Stop the crane, by pressing the stop button.
3. Remove the locking device ① and the locking pin ②.
4. Extend the manual extension fully by hand.
5. Secure the manual extension, by locking the pin ② and locking device ①.

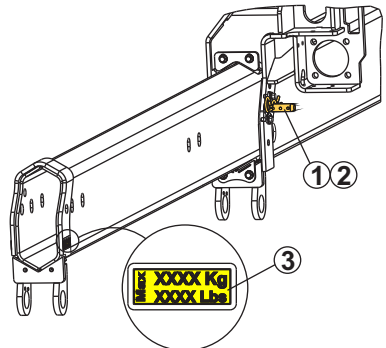

### DANGER

- Make sure that the locking device is properly locked.
- Each manual extension has a sign ③ for the maximum load that can be handled.
- Do not lift loads heavier than the values stated on the hook attachment.



To lift heavier loads than specified on the sign ③, the hook position must be moved to the nearest hydraulic extension, in accordance with the load plate on the crane.

### To retract the manual extensions

1. Locate the boom system as close as possible to the horizontal position, but low enough to reach the extension by hand.
2. Stop the crane, by pushing the stop button.
3. Remove the locking device ① and the locking pin ②.
4. Retract the manual extension fully by hand.
5. Secure the manual extension, by locking the pin ② and locking device ①.

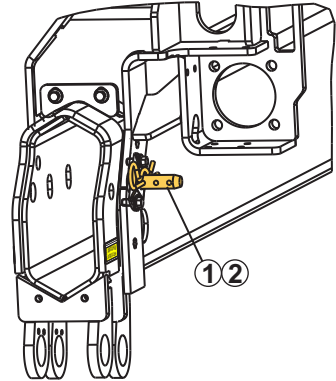

**⚠ DANGER**

- Make sure that the locking device is properly locked.

### Activate and de-activate OLP for manual extensions on the user panel

**⚠ WARNING**

You must switch the OLP on and off manually for additional manual extensions!

#### Activate:

Push button  on the user panel.

The manual extensions are now included in the OLP protection. The lifting capacity will be reduced automatically. The lamp for  lights up on the user panel.

#### De-activate:

Push the button again. The lamp for  goes out.

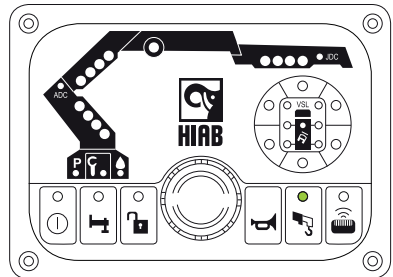

### Activate and de-activate OLP for manual extensions on the XSDrive controller



#### WARNING

You must switch the OLP on and off manually for additional manual extensions!

#### Activate:

Push buttons  and  on the controller.

The manual extensions are now included in the OLP protection. The lifting capacity will be reduced automatically. The lamp for  lights up on the user panel.

#### De-activate:

Push the buttons again. The lamp for  goes out.

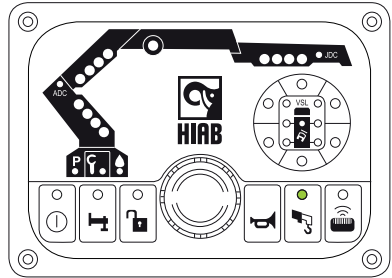
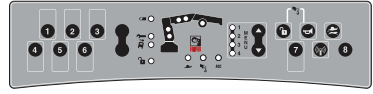

**Activate and de-activate OLP for manual extensions on the CombiDrive controller**

**⚠ WARNING**  
 You must switch the OLP on and off manually for additional manual extensions!

**Activate:**

Push both button ① and ② until symbol  on the centre display is lit.

(The lamp for manual extension is lit on the user panel.)

The manual extensions are now included in the OLP protection. The lifting capacity will be reduced automatically.

**De-activate:**

Push the button ① and ② again. The symbol  on the centre display goes out.

(The lamp for manual extension goes out on the user panel.)

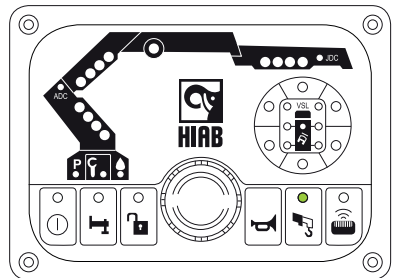
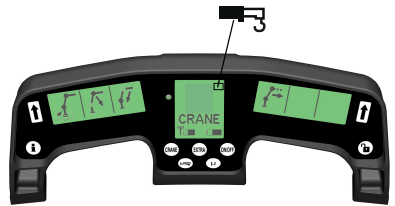
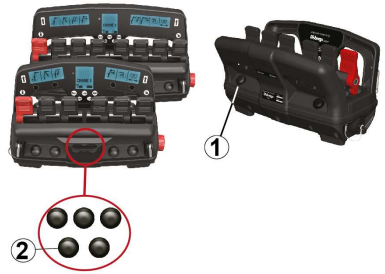

### 7.1 Operate the boom system into transport position



#### **WARNING**

- A crane with add-on equipment can differ from the operations described in this section.
- For this reason, study the operating instructions for any add-on equipment carefully.

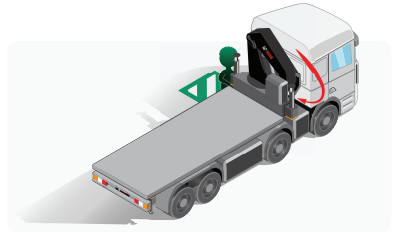

#### **DANGER**

- During folding of the boom system, always operate the crane manually from the position indicated in the figure.
- With remote controlled cranes, stay in a safety area while the boom system is moving.

## 7.1.1 Operate the boom system

## • HIAB 358 / 408 / 418:

1. Retract the extensions completely ①.
2. Raise the first boom ② until BDA allows you to operate the second boom or  $\beta > 135^\circ$ .
3. Slew the crane to parking position. Check that arrows "A" are aligned.

LED for the parking control **P** will light blue on the user panel [If fitted].

4. Operate the second boom to vertical position ③ as shown in the figure. To be able to lock the extensions, slide out the first extension ④ about 500 mm until plate "B" is shown.

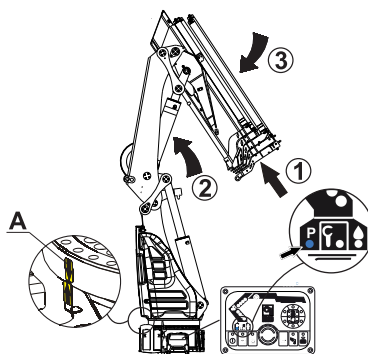
**CAUTION**

Pay careful attention not to damage the slewing motors.

5. Adjust the second boom ⑤ and retract the first extension slowly ⑥ to ensure that the extension "C" is locked by the parking support "D".

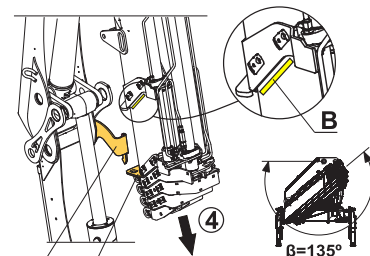
**CAUTION**

Take care not to damage the parking pin and parking support during these operations.

6. Lower the first boom completely ⑦ on to the parking support "E", on the crane base.
7. Lock the boom with the locking pin ⑧.
8. Fold the hook.

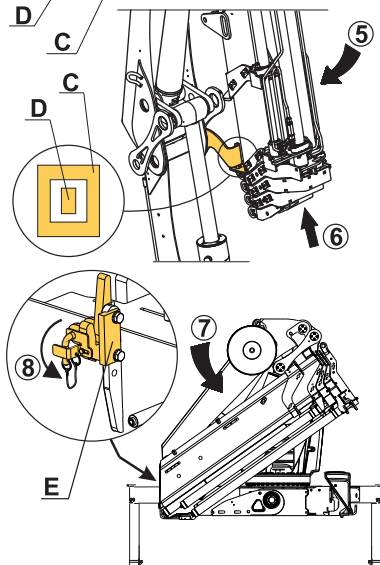

## 7.2 Placing the stabiliser system in the transport position



### DANGER

Do not stand in the stabiliser legs, tilting area.



### WARNING

Do not put your foot on the support plate.

Risk of crushing injuries.

Always keep hands away from moving parts during operation.

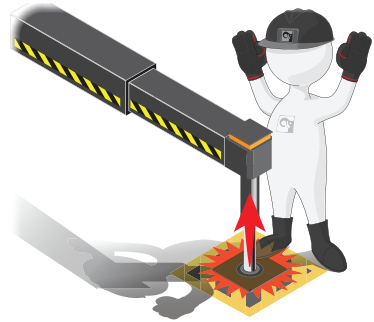



The procedure of operating the stabiliser legs differs depending on the type of stabiliser leg. Repeat the instructions for the stabiliser extension and leg on the other side of the vehicle. For auxiliary stabiliser system [option]: Repeat the process.



### DANGER

Always ensure that the stabiliser legs and the stabiliser extensions are in transport position and securely locked before moving the vehicle.

- Manually controlled crane: Activate stabiliser system operation on the user panel by pressing button .
- Remote controlled crane:
  - Manually controlled stabiliser system: Press button  on the user panel to deactivate the controller. Activate stabiliser system operation on the user panel by pressing button .
  - Remote controlled stabiliser system: Select on the controller the defined menu for the stabiliser system operation.

### Non-tiltable stabiliser legs

1. Raise the stabiliser leg.
2. Retract the stabiliser extension completely.



#### **DANGER**

**Risk of crushing injuries.**

**Always keep hands away from moving parts during operation.**

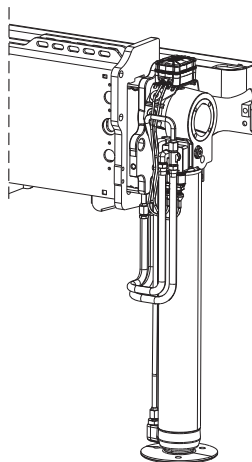

**Manual tiltable stabiliser legs**

1. Raise the stabiliser leg completely.
2. Unlock the stabiliser leg lock ①.
3. Tilt the stabiliser leg manually.
4. Lock the stabiliser leg lock ①.
5. Retract the stabiliser extension completely.

**DANGER**

**Risk of crushing injuries.**

**Always keep hands away from moving parts during operation.**

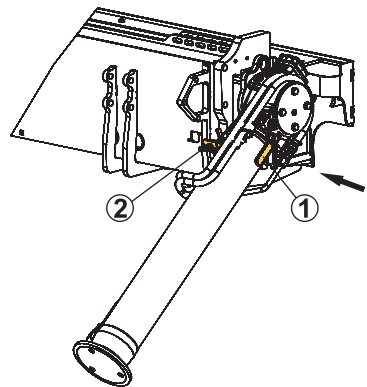
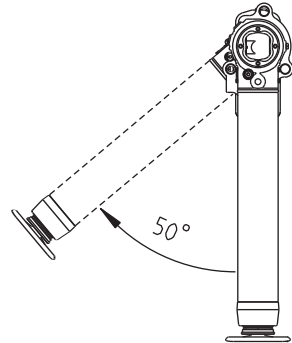
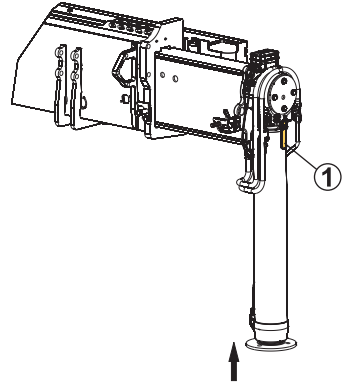



### Manually tiltable stabiliser legs with gas spring support

1. Raise the stabiliser leg completely.
2. Place your right hand on the handle ③ while unlocking the stabiliser leg ④ with your left hand.
3. Gently pull the stabiliser leg upwards until it stops. Make sure the leg travels in a controlled movement.
4. Push the leg up until it reaches parking position.
5. Lock the stabiliser leg.
6. Retract the stabiliser extension completely.

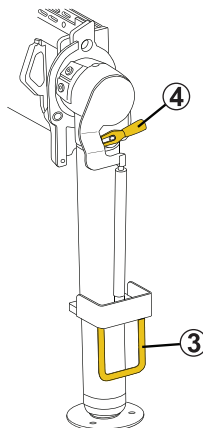

#### DANGER

**Risk of crushing injuries.**

**Always keep hands away from moving parts during operation.**

### Mechanically controlled tiltable stabiliser legs [AR+]

1. Raise the stabiliser leg so it is just free of the ground.
2. Unlock the leg ① .  
Raise the stabiliser leg. When 200 mm remains, the leg will start to tilt upwards.
3. Lock the stabiliser leg lock ① .
4. Retract the stabiliser extension completely.

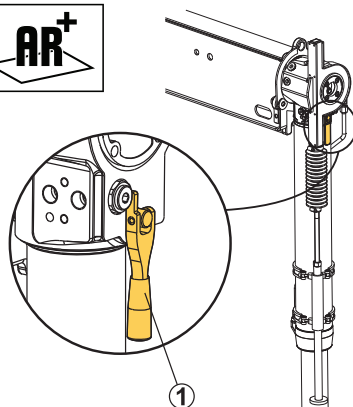

#### DANGER

**Risk of crushing injuries.**

**Always keep hands away from moving parts during operation.**

### Retract the stabiliser extensions

The procedure of retracting the stabiliser extensions differs depending on the type of stabiliser extensions. Repeat the instructions for the stabiliser extension on the other side of the vehicle. For auxiliary stabiliser system [option]: Repeat the process.

### Hydraulically controlled stabiliser extensions

Retract the stabiliser extensions with the levers on the valve or the controller depending on your crane configuration. Make sure that the stabiliser locking device ② [option] is securely locked.

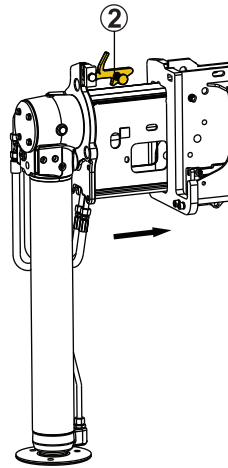

#### WARNING

Always ensure that the stabiliser legs and stabiliser extensions are in transport position and securely locked.

### 7.3 Switching off the control system

- Switch off the control system with the on/off button ⑩.

#### If you are using the remote controller:

- Push the stop button on the controller and switch off the control system.
- Disengage the PTO.

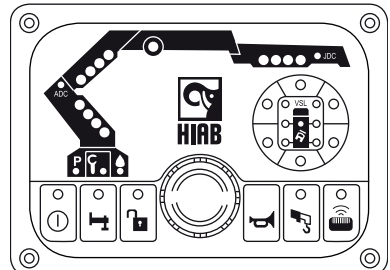

## 7.4 Emergency operation Valve-V200

**EMERGENCY** operation to bring the crane to transport position

**Do like this:**

**Crane:**



### **DANGER**

To operate the crane like this is **HIGHLY DANGEROUS** because during emergency operation all crane security is disconnected.

**Always go to/contact a HIAB service workshop when the seal wire has been broken.**

1. Engage the pump.
2. Break the security sealing on Dump valve 1 ① on the supply unit.
3. Use a screw driver (or similar) and push the knob on Dump valve 1 ①.
4. Check that no unintended movements starts. If you get unintended movements then release the knob and contact HIAB service.
5. Push the dump valve button and turn 90 degrees until it is blocked.
6. Operate the crane to transport position using the levers on the main control valve.

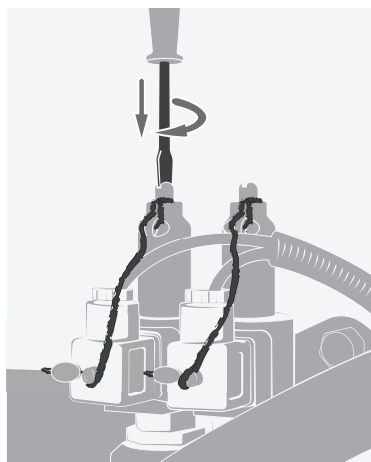
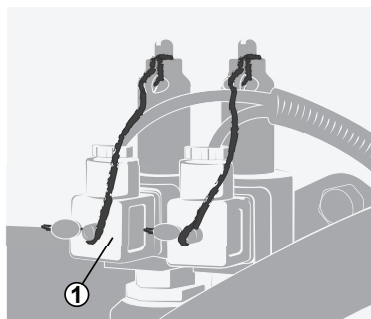

## Stabiliser extensions and legs:

**DANGER**

To operate the crane like this is **HIGHLY DANGEROUS** because during emergency operation all crane security is disconnected.

**Always go to/contact a HIAB service workshop when the seal wire has been broken.**

1. Follow actions 1-5 in previous section "EMERGENCY operation to bring the crane to transport position". The button on dump valve 1 on the main control valve is to remain depressed.
2. Break the security sealing on Dump valve 2 ② on the supply unit.
3. Check that no unintended movements starts. If you get unintended movements then release the knob and contact HIAB service.
4. Push the dump valve button and turn 90 degrees until it is blocked.
5. Operate the stabiliser extensions and stabiliser legs to parking position using the levers on the stabiliser control valve.

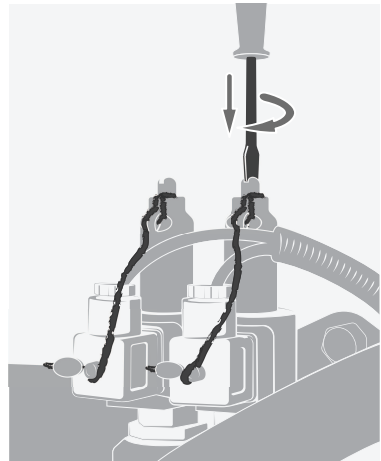
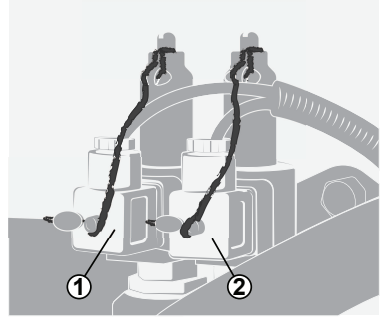

### 7.5 TWI Transport warning interface [option]

**WARNING**

If you switch off the safety system when manual operated stabiliser extensions/tiltable stabiliser legs are not locked in the transport position, and/or if the first boom angle exceeds a certain specified angle, the indicator lamps for both the cylinders and the hoist will flash red for a while.

**The vehicle must not be moved.**

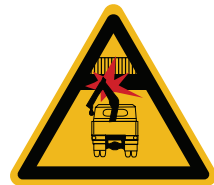

- A warning, visible and audible from the driving position for transport, indicates when the crane height exceeds a predetermined maximum and when the manual operated stabiliser extensions/tiltable stabiliser legs are not locked in the transport position.
- The audible warning can be silenced by an acknowledgement button [option] or by a signal indicating that the parking brake of the vehicle is engaged.

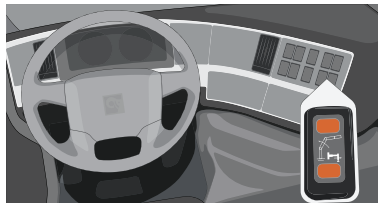

### The vehicle must not be moved

1. Switch the system on, put the crane into the transport position.
2. Switch off the system. The vehicle may be moved.



### **DANGER**

After use always put the crane into the transport position! When you have to park the boom on the load space, or over the load, secure the boom and the lifting accessories to prevent any unintentional movement of the crane and the lifting accessories.

## 8.1 Service



### DANGER

- Do not do any welding work on the crane yourself! Welding work on the crane may only be carried out by, or in close consultation with, a HIAB service workshop.
- Do not drill into the crane yourself. Drilling work on the crane may only be carried out by, or in close consultation with, a HIAB service workshop.
- Never try to reinstall the crane. Only a HIAB Dealer may reinstall the crane.



### **Before carrying out any welding on the vehicle:**

- Disconnect the power between the vehicle and the crane.
- Contact the vehicle manufacturer.

### **After welding on the vehicle:**

- Connect the power between the vehicle and the crane.

---

**Leakage****DANGER**

- Keep well away from an oil leak on the hydraulic system! The oil spraying out can cause serious injury. The oil in the hydraulic system is under high pressure.
- Do not replace any hydraulic hoses or lines yourself: Precautions shall be taken when disconnecting hydraulic lines and hoses to ensure that no hydraulic pressure is retained in the line when the power supply to the system is switched off. Pressure may be retained in the hydraulic lines when the power supply has been switched off.
- Always contact a HIAB service workshop.

**Deal with an oil leak as follows:**

1. Rest the crane on the floor or on the truck platform.
2. Switch off the operating system.
3. Disengage the PTO.
4. Leaking coupling:  
Tighten the coupling with a spanner.  
If tightening does not help: contact a HIAB service workshop.
5. Small leak on a line or hose:  
Determine if you can still park the crane.  
If you can: park the crane and go to a HIAB service workshop. If you cannot: contact a HIAB service workshop.
6. In all other cases, contact a HIAB service workshop.

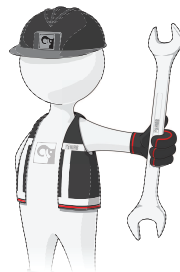

## 8.2 Warranty

**HIAB only provides a warranty if:**

- The "Warranty – Terms and Conditions" specified in the "Service & Warranty Manual" are fulfilled.

- The crane is inspected and maintained, at least once a year, by a Hiab service workshop as specified in the "Service & Warranty Manual".
- HIAB parts are used for every repair or maintenance work.
- All security seal wires on the valves are still intact.

**Always use original HIAB parts and tools.**

### **8.3 Follow the maintenance instructions!**

Take the crane, at least once a year, to a HIAB service workshop for inspection and maintenance. Maintain lifting accessories according to the supplier's instructions.



#### **WARNING**

- Ensure that faults in the crane are corrected immediately!
- Never correct faults yourself that may only be corrected by a HIAB service workshop.
- Carry out yourself only the service and maintenance work you have the requisite knowledge and experience of.

**If the crane is not to be used for 1 month or longer:**

- Lubricate the crane thoroughly, according to the lubrication schedule.
- Park the crane in the transport position.

#### **Filters**

Replace the filter cartridge

- after the first 50 hours operation
- then after every 1000 hours operation
- or at least once a year.



---

## Cleaning

Clean your crane and accessories regularly, but:

- Do not use aggressive cleaning agents.
- Never use a high pressure jet cleaner on electronic parts, plastic components, signs, bearings, control valves, cylinders or the oil tank. Only the cranes surface may be cleaned with a high-pressure jet cleaner.

### 8.3.1 Daily inspection

Refer to the daily inspection checklist at the end of this manual to photocopy.

#### Presence of signs and symbols

- See chapter Safety precautions and warnings under section Signs on the crane. Make sure that all the signs shown in section "Signs on the crane" are in position and in good conditions .
- Make sure that all the symbols on your crane are in good conditions.

#### Locking devices

- Make sure that the locking devices are undamaged and working properly.
- Make sure that the locking devices are properly locked.

#### Shafts, shaft lockings, bearings and bushings

- Check that the shafts, shaft lockings, bearings and bushings are undamaged and working properly.

#### Stop buttons

- Check that the Stop buttons are undamaged and working properly.

#### Levers

- Check that the levers operate smoothly.
- Check that the levers return to neutral position.

**Controller**

- Do a check of the controller functionality.

**Crane structure**

- Check for damage to the crane structure (e.g. any formation of cracks).

**DANGER**

In the event of damage that presents a safety risk:

- Do not use the crane.
- Have the damage repaired immediately by a HIAB service workshop.

**Hooks**

Before every lift:

- Check general condition of the hook, and parts of the hook ① for deformation and surface damages with significant depth.
- Check for damage to the hook structure (e.g. any formation of cracks).
- Check that the latch ② closes entirely.
- Check that the shaft ③ and the locking pin ④ are in place.
- Check that the plane bearing ⑤ or the swivel ⑥ are in good conditions.

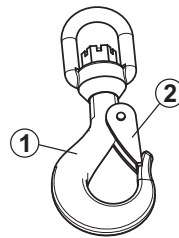
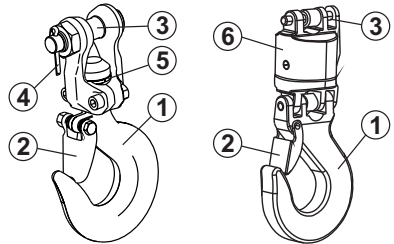
**DANGER**

In the event of damage or worn that prevents a safety risk:

- Do not use the hook.
- Have the damage repaired immediately by a HIAB service workshop.

---

**Add-on equipment and separate accessories  
(hoist etc.)**

- Check the cables, cable connections, the cable guides and the attachment points for the add-on equipment.
- Maintain all add-on equipment, separate accessories, auxiliary equipment etc. according to the instructions supplied with it.

**Electronic components**

- Check that these are in good condition.
- LED test

To do the test:

1. Press the ON/OFF button for at least 2 sec.  
The test is activated and all the red LEDs are illuminated.

If the system is equipped with warning lights / lamp pole, lamps will come on.

2. Release the button. After 3 sec, all the green the LEDs are illuminated. The test is finished when all LEDs is extinguished.

**Hydraulic system**

- Check that there are no leaks from the hydraulic hoses, lines and connections.
- Make sure that all security seal wires (Ex. LHV, dump valves, etc...) are not broken. Always go to/contact a HIAB service workshop when the seal wire has been broken.
- Check oil level in the tank. If necessary, fill to correct level.

**! NOTE**

Always place the vehicle on level ground with the crane in transport position while checking the oil.

**Oil level in the slewing motors**

- Do a check of the oil level in the gearbox of the slewing motors. If necessary, fill to correct level.

**Filters**

- Check the filter indicator. If red, replace the cartridge.

**8.3.2 Monthly inspection and maintenance**

In addition to the daily inspection, carry out the following each month:

**Piston rods**

- In cases where the cylinder piston rod is exposed to pollution due to the parking location, the chromed surfaces must be cleaned and oiled to prevent corrosion. This needs to be done regularly.

**Pivot pins and bushes**

- Inspect all the pivot pins and bushings for the crane boom and cylinders for damage, play, etc.

**Bolts and screw fixings**

- Check that bolt and screw fixings are not loose. If loose contact a HIAB service workshop

**Cables and sensors**

- Check that these are in good condition.

**Lubrication schedule**

- Carry out the lubrication according to the instructions.

**Slewing bearing / Upper column bearing**

- Check that the slewing bearing / upper column bearing is lubricated sufficiently.

**Hydraulic system**

- Check that the hydraulic pump attachment screws are tightened.
- Check if the oil in the hydraulic system needs to be changed.
- Or have the oil tested by a workshop or specialist.

**Add-on equipment etc.**

- Maintain all add-on equipment, auxiliary equipment etc. according to the instructions supplied with it.

**8.3.3 Annual maintenance**

Take the crane, at least once a year, to a HIAB service workshop for inspection and maintenance.

Carry out the following maintenance at least once a year.

**Hydraulic oil**

- Change the hydraulic oil.  
Or have it tested by a workshop or specialist.

**Oil in the slewing gear boxes**

- Change the oil in the slewing gear boxes.  
Or have it tested by a workshop or specialist.

**Hydraulic system oil tank filler cap**

- Change the filler cap.
- Replace filters.

**Slewing bearing**

Check the tightening torque:

- The bolts must be carefully retightened to the torque value recommended in the technical specification. Contact a Hiab workshop.
- Check and retighten fastening bolts of the slewing bearing to the frame:
  - Remove cover ① .
  - Retighten fastening bolts through the hole ② .

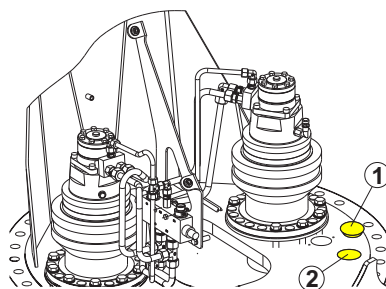

## 8.4 Lubrication



### WARNING

Follow the lubrication schedule exactly. If you do not do so, you can cause serious damage to the crane and to add-on equipment.

### Type of grease

Use lithium based grease containing EP additives (consistencies 2 and 3 are recommended, depending on the climate).

### Recommended greases:



BP LS EP 2, ESSO UNIWAY EP2 N, AGIP GR MU/EP3, NYNÄS UNIFETT EP.



### ! NOTE

Avoid grease with graphite or molybdenum-disulphide additives.

8.4.1 Lubrication schedule [AR+]

	Lubricate after every 16 hours of use.
	Lubricate after every 50 hours of use.
	Grease after every 50 hours of use.

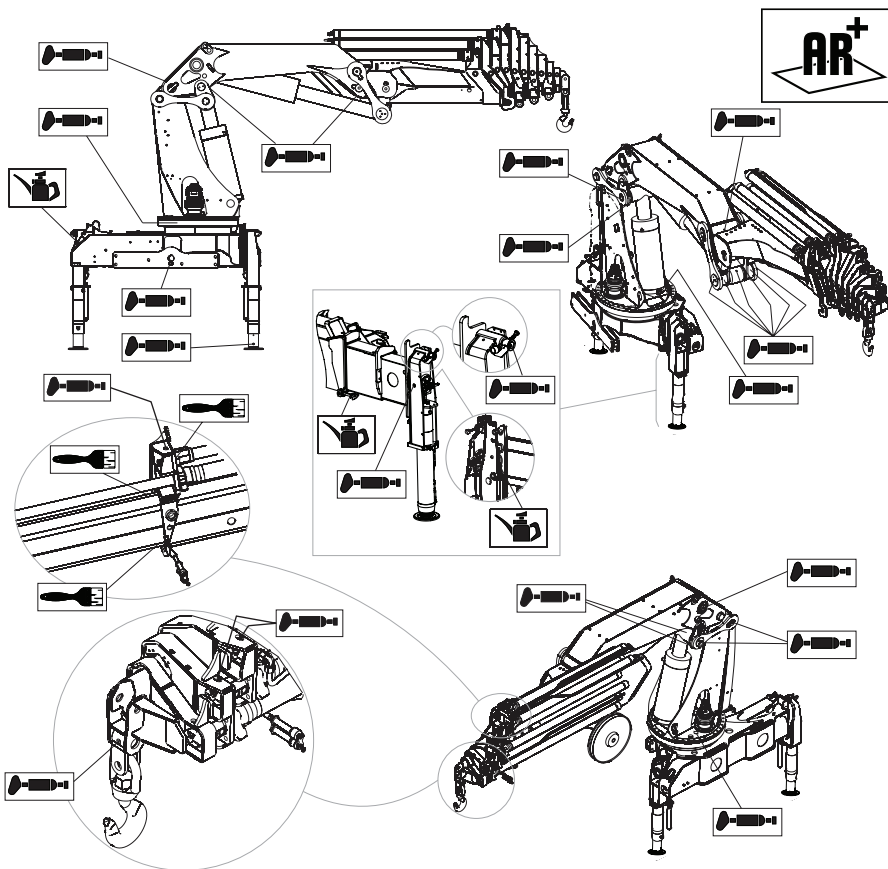

### 8.4.2 Lubrication of the gearbox

An oil change must be carried out after approximately 150 operating hours. Thereafter change should be repeated approx. every 2000 or 4000 operating hours depending on working conditions.

Change the oil at least once a year. Refill with oil SAE 80W/90.



#### ! NOTE

Remove the plug ① and before replacing oil, drain all oil from gear case, flush carefully the internal side of the gearbox with the appropriate washing compound. Refill through plug ②.

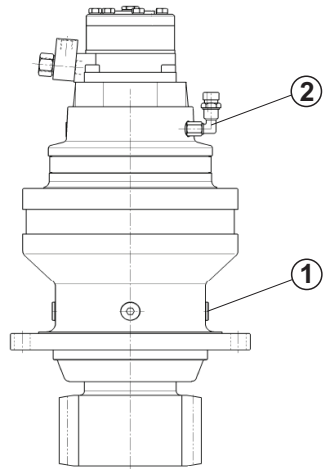

### 8.4.3 Lubrication of the slewing bearing

- Remove cover ① .
- Check that there is enough lubrication film ② , grease if necessary:
  - Grease through the grease nipple in the cover ① .
  - Grease to be used is marked ◆ in table.

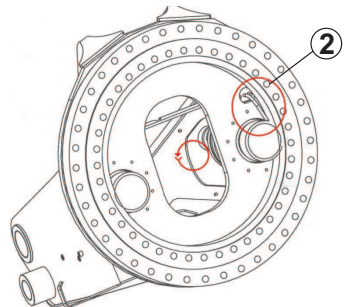
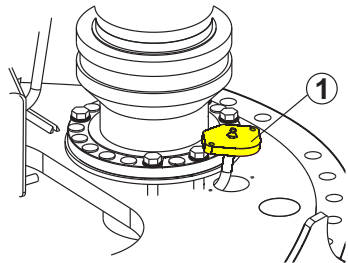





### 8.4.4 Lubrication of bearing assemblies

	<input type="checkbox"/>	Aralub HLP 2	248 K to 403 K (-25° to +130°)
	◆	Aralub MKA-Z 1	248 K to 403 K (-25° to +130°)
	<input type="checkbox"/>	Energrease LS-EP-2	248 K to 403 K (-25° to +130°)
	◆	Energrease LC 3	243 K to 433 K (-30° to +160°)
	<input type="checkbox"/>	Spheerol EPL 2	253 K to 393 K (-20° to +120°)
	◆	Viscogen 0	238 K to 398 K (-35° to +125°)
	<input type="checkbox"/>	EPEXA 2	243 K to 393 K (-30° to +120°)
	◆	CADREXA GR 1-AL	243 K to 393 K (-30° to +120°)
	<input type="checkbox"/>	BEACON EP2	248 K to 403 K (-25° to +130°)
	◆	Esso Multi-Purpose Grease (Moly)	248 K to 423 K (-25° to +150°)
	<input type="checkbox"/>	CENTOPLEX 2 EP	253 K to 403 K (-20° to +130°)
	◆	GRAFLOSCON C-SG 0 plus	243 K to 473 K (-30° to +200°)
	<input type="checkbox"/>	Mobilux EP-2	253 K to 393 K (-20° to +120°)
	◆	Mobiltac 81	243 K to 393 K (-30° to +120°)
	<input type="checkbox"/>	Lagermeister EP 2	253 K to 393 K (-20° to +120°)
	◆	Ceplattyn KG 10 HMF	243 K to 523 K (-30° to +250°)

## 8.4.4

## Maintenance and Service

	☐	Shell Alvania EP 2	248 K to 403 K (-25° to +130°)
	◆	GREASE S.8327	253 K to 503 K (-20° to +230°)
	☐	Multifak EP 2	243 K to 403 K (-30° to +130°)
	◆	Spectron ZKF-EP 0	253 K to 423 K (-20° to +150°)

- Lubricate the bearing assemblies approximately every 100 working hours.
- Lubrication is made by injecting 5 cm<sup>3</sup> approximately into each grease nipple around the bearing.
- Grease to be used is marked ☐ in table.
- Bearing should be rotated during lubrication.
- The grease filling is there to reduce friction, seal the bearing and provide protection against corrosion.
- Before and after prolonged stop of the crane, lubrication is absolutely necessary. This is especially important after a winter shutdown.

## 8.4.5 Lubrication of slide pads in the boom system

### Side slide pads

- Extend all the extensions completely.
- Lubricate through the holes.
- Retract the extensions.

### Upper slide pads

- Extend extensions with load in order to create enough clearance.
- Lubricate.

### Lower slide pads

- Extend extensions without load and push slightly against the ground in order to create enough clearance.
- Lubricate.

### Recommended greases:

- Upper / lower slide pads (**Black / White colour**):  
BP LS EP 2, ESSO UNIWAY EP2 N, AGIP GR MU/EP3, NYNÄS UNIFETT EP.
- Upper / lower slide pads (**Grey / Purple colour**):  
LAGERMEISTER WHS 2002

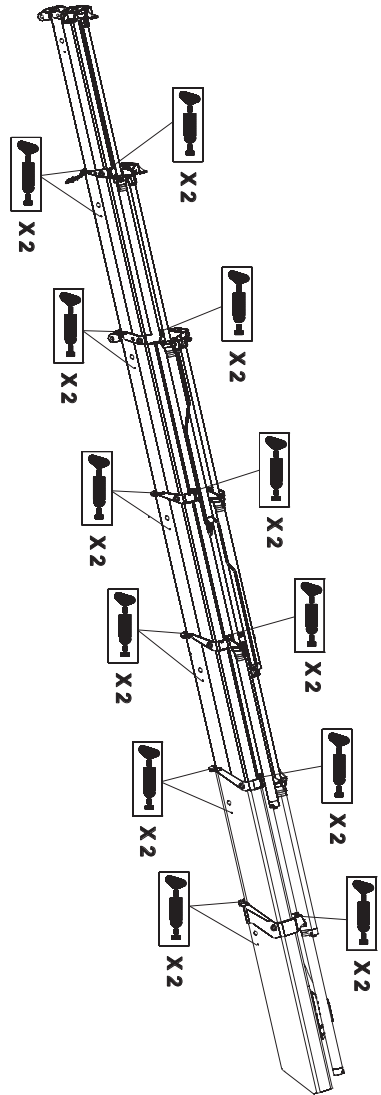

## 8.4.6 Lubrication of the hooks

### • Hooks with plane bearing.

If the hook cannot rotate easily without load:

1. Lubricate the plane bearing surfaces ①.  
Use a heavy duty penetrating spray grease, type "ZEP 2000" or equivalent quality.

### • Hooks with swivel.

Lubricate if the swivel cannot rotate easily:

1. Remove the screw ② and mount a grease nipple.
  2. Add grease until grease appears between house ③ and shank ④.
  3. Mount the screw ②.
- Use a bearing grease, type "Texaco Multifak EP 2" or equivalent quality.

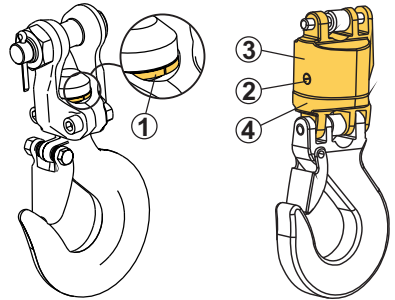

## 8.5 Hydraulics

### 8.5.1 Replacing the cartridge in return oil filter

#### Return oil filter with clogging indicator



#### ! NOTE

Do not clean the filter.

Replace the breathing filter of the filler cap at the same time as the return filter cartridge.

When clogging indicator turns red or filter time is reached (whichever is the sooner), the cartridge must be replaced. **If indicator is not fitted, replace the cartridge periodically as recommended by Hiab.**



#### WARNING

Dirt will damage the hydraulic system

Make sure that the area around the filter is clean to prevent contamination of the hydraulic oil.

1. Switch off the hydraulic system and release the filter of pressure.
2. Clean the immediate surrounding area of the filter.
3. Remove the cover.
4. Remove the filter cartridge with attached filter housing by using the handle.
5. Examine the surface of the filter cartridge for dirt residue and larger particles; these can indicate damage to the components.
6. Examine the filter housing for any possible mechanical damage.
7. Replace the filter cartridge with a new one.
8. Remove old O-rings and replace (oil before assembling).
9. Place the filter cartridge carefully into the filter housing and screw. Pay attention to the position of the handle.
10. Install the filter cartridge with attached filter housing.
11. Refit the cover.
12. Replace the breathing filter in the filler cap.
13. Switch on hydraulic system and check the filter for leakage.

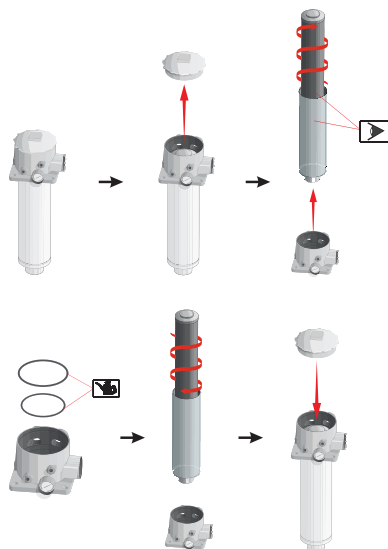

### 8.5.2 Replacing the cartridge in pressure-reducer filter - V200

The pressure-reducer filter is located in the main control valve or in the supply unit [option]

**WARNING**

Dirt will damage the hydraulic system

It is not possible to clean the cartridge. It must always be replaced.

1. Switch off hydraulic system. Release filter from pressure.
2. Carefully clean the filter housing and the surrounding area on the housing.
3. Remove the filter housing using a 27 mm wrench.
4. Remove the old O-ring and replace it with the supplied one (oil it before assembling).
5. Remove the filter cartridge. Examine the surface of the filter cartridge for dirt residue and larger particles; these can indicate damage to the components.
6. Clean the filter housing.
7. Unpack the new filter cartridge. Make sure that it is clean and screw carefully.
8. Remount the filter housing and tighten it, torque 40-60 Nm.
9. Switch on hydraulic system and check the filter for leakage.

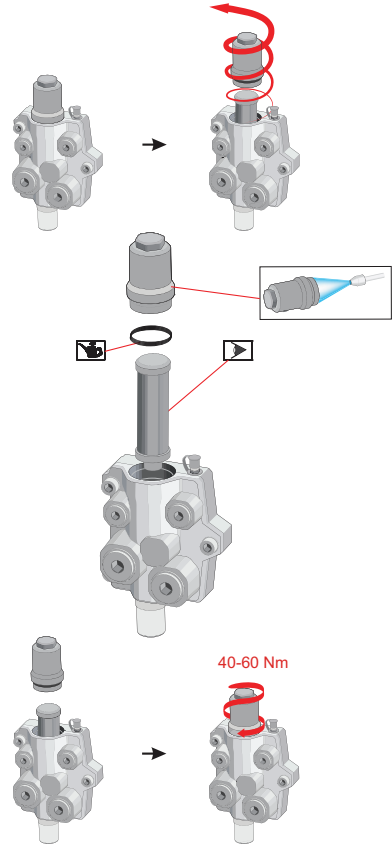

### 8.5.3 Replacing the cartridge in pressure-reducer filter - V80R

**V80R - External filter for the main control valve**

**WARNING**

Dirt will damage the hydraulic system

It is not possible to clean the cartridge, it must always be replaced.

1. Switch off hydraulic system. Release filter from pressure.
2. Clean the immediate surrounding area of the filter.
3. Remove the oil drain plug, if fitted. Collect oil in a suitable container.
4. Unscrew the filter housing. Collect oil in a suitable container and clean or dispose of it in accordance with environmental regulations.
5. Remove the filter cartridge. Examine the surface of the filter cartridge for dirt residue and larger particles; these can indicate damage to the components.
6. Clean the filter housing.
7. Examine the filter housing and head segment, especially sealing surfaces and thread, for mechanical damage.
8. Always replace the O-ring of the filter housing.
9. Oil the threads and sealing surfaces on the filter housing and head segment, as well as the O-ring.
10. Replace the filter cartridge with the new one and screw carefully.
11. Fully tighten the filter housing by hand. Then, unscrew it 1/4-turn back.
12. Screw the oil drain plug.
13. Switch on hydraulic system and check the filter for leakage.

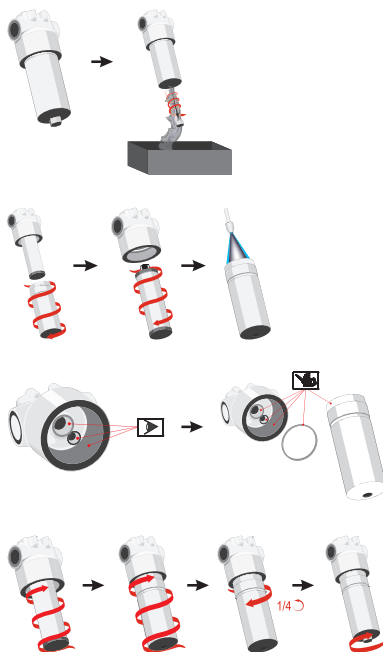

**V80R - Internal filter in the stabiliser control valve****WARNING**

Dirt will damage the hydraulic system

It is not possible to clean the cartridge, it must always be replaced.

This filter is used only in V80R stabiliser control valves that are used together with a non-V80R main control valve.

1. Switch off hydraulic system. Release filter from pressure.
2. Clean the immediate surrounding area of the outlet section of the stabiliser control valve/s.
3. Remove the plug using a 6 mm hexagonal wrench.
4. Remove the spring together with the filter from the hole.
5. Examine the surface of the filter for dirt residue and larger particles; these can indicate damage to the components.
6. Replace with a new filter kit.
7. Tighten the plug, torque 30 Nm.
8. Switch on hydraulic system and check for leakages.

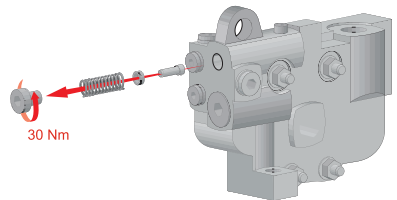



## 8.5.4 Replacing the cartridge in high pressure filter

High pressure filter ①

Optical indicator ②

Cartridge ③



### WARNING

Dirt will damage the hydraulic system

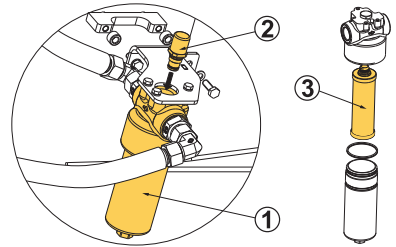



## ! NOTE

DO NOT clean the filter cartridge.

When clogging indicator turns red or filter time is reached (whichever is the sooner), the cartridge must be replaced. **If indicator is not fitted, replace the cartridge periodically as recommended by Hiab.**

1. Switch off hydraulic system. Release filter of pressure.
2. Clean the immediate surrounding area of the filter.
3. Remove the oil drain plug. Collect oil in a suitable container.
4. Unscrew the filter housing. Collect oil in a suitable container and clean or dispose of it in accordance with environmental regulations.
5. Remove the filter cartridge. Examine the surface of the cartridge for dirt residue and larger particles; these can indicate damage to the components.
6. Clean the filter housing.
7. Examine the filter housing and head segment, especially sealing surfaces and thread, for mechanical damage.
8. Always replace the O-ring of the filter housing.
9. Oil the threads and sealing surfaces on the filter housing and head segment, as well as the O-ring.
10. Replace the filter cartridge with the new one and screw carefully.
11. Fully tighten the filter housing. Then, unscrew it 1/4-turn back.
12. Screw the oil drain plug.
13. Switch on hydraulic system and check the filter for leakage.

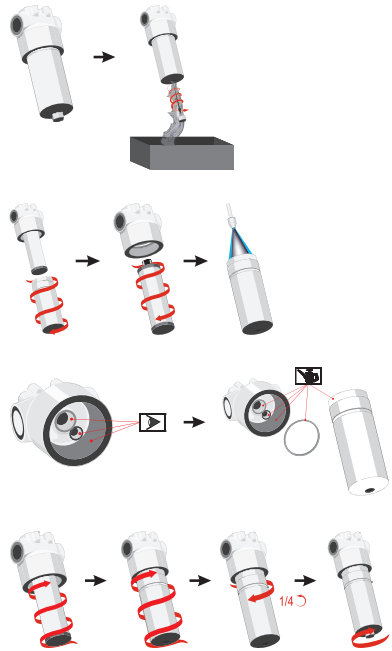

### 8.5.5 Checking the oil tank level

1. Place the crane and stabiliser legs in the transport position.
2. Place the vehicle on level ground.
3. Check the oil level in the tank.
4. Oil level too low:  
Top up with hydraulic oil.



### 8.5.6 Changing the hydraulic oil



#### WARNING

The oil can be hot and cause injury.

1. Operate the crane for a while to warm the oil. Place the crane in the parked position. Take care that the temperature of the oil does not exceed the point where you can handle it safely. If this occurs allow the oil to cool before moving to the next step.



#### WARNING

- Suitable eye and hand protection must be worn while carrying out this operation, and if there is a risk for inhalation of oil mist, a mask as well.
- Inhalation of oil mist: Contact a doctor.
- Skin contact: Remove polluted clothing, wash with soap and water. In the event of high pressure injection of the product, see a doctor without delay.
- Eye contact: Rinse eyes with plenty of water, see a doctor if irritation persists.

2. Drain the oil tank through the drain plug. Make sure the system contains as little as possible.  
Use a container with sufficient capacity.



### ! NOTE

Ensure the waste oil is disposed of safely and in accordance with local environmental regulations.

3. Change at the same time:
  - all filters
4. Refit the drain plug.

### Filling the oil tank with hydraulic oil

The oil used for filling must be clean. Do not mix different oils.

Hydraulic oils must have been dealt with according to cleanliness requirements ISO 4406: - /16/13.

Hydraulic oil that is approved for HIAB products must comply with one of the following standards or equivalents:

- ISO 11158 HV
- DIN 51524 part 3 HVLP
- ISO 6743/4 L-HV

Suppliers of hydraulic oil must verify that the quality and performance of the oil complies with the above standards.

When changing from mineral oil to a non-polluting synthetic oil, or when changing to biodegradable oil, contact a HIAB service workshop.

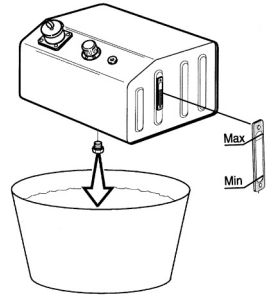

### Viscosity of oil

The viscosity of the oil is of great importance to achieve high efficiency of the hydraulic system.

The naming of the oil in the table below: 32, 46 or 68 tells the viscosity of that oil at 40°C (reference temperature).

Viscosity of oil at 40°C	Temperature range
32	-25°C to 75°C
46	-15°C to 90°C
68	-5°C to 90°C

The recommended viscosity during normal working conditions is between 16 and 40cSt.

HIAB strongly recommend an oil working temperature below 70°C. If necessary consider an oil cooler or heater.



#### ! NOTE

When working in arctic condition consider an oil with lower viscosity than the 32 oil in the table above.

### Environmentally Friendly Oil

The environmentally friendly oils recommended for HIAB products are ester based synthetic hydraulic fluids (synthetic ester).



#### ! NOTE

**Vegetable oils do not meet HIAB's requirements and must not be used.**

### After filling the tank

1. Operate each crane function to its end positions.
2. Operate the crane to parking position.
3. Check and top up the oil tank to max level on the tank gauge.
4. Bleed the system.

## 8.5.7 Bleeding air from the hydraulic system

### Bleed the air from the hydraulic system:

- after changing the hydraulic oil
- after working on the hydraulic system
- if your crane works slowly or jerkily
- if your crane has not been used for a long time



### WARNING

Air in the hydraulic system can lead to faults and damage

### To bleed air from the hydraulic system, proceed as follows:

Move each crane cylinder and each hydraulically operated piece of add-on equipment at least twice to its end positions (slowly).

## 8.6 Troubleshooting

### 8.6.1 Main fuses

If the microprocessor detects a fault, this must be rectified immediately.

Fault	Probable cause	Action
<p>The control system does not work at all.</p> <p>The indicator light next to On/Off button on the user panel is not lit, even if you push On/Off.</p>	<p>Defective fuses.</p>	<ol style="list-style-type: none"> <li>1. Replace faulty fuses in the: <ul style="list-style-type: none"> <li>- vehicle</li> <li>- standard box</li> <li>- relay box</li> </ul>           (See Description, Components, Fuse, Location)         </li> <li>2. Check all the cable connections.</li> </ol>

Description	Components	Fuse	Location
System main fuse	Relay Box, Standard Box, Oil Cooler	40 A	Located on the vehicle, where the crane is mounted.
Fuse for all components controlled by the relay box.	Hydraulic main control valve, stabiliser leg warning lamp, Remote control, user panel, MUX box. Truck warning interface, Work lights.	15 A	Located inside the relay box ①.
Fuse for all components connected to the standard box.	Hydraulic main control valve, stabiliser leg warning lamp, user panel, MUX box. Truck warning interface.	10 A	Located inside the standard box ②.

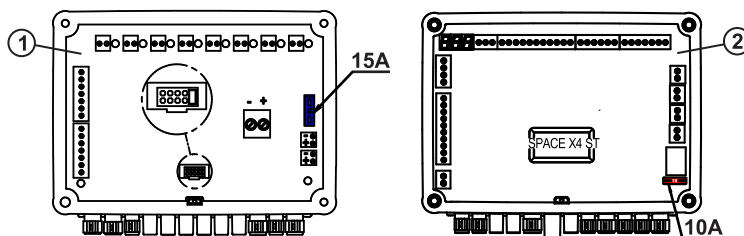

8.6.1.1 Main fuses CD

Description	Components	Fuse	Location
Fuse for all components controlled by the radio decoder	DA-26	10 A	Located inside the radio decoder. ③
Fuse for DA-26	Remote controlled valves	2x10A	Located inside the DA-26. ④

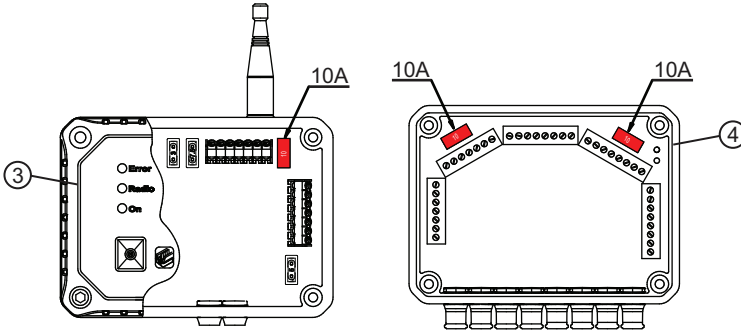

### 8.6.2 Faults on the crane

Faults in the crane must be rectified immediately.

**⚠ DANGER**

- Only correct yourself the faults that according to the table you may rectify.
- Follow the instructions exactly!
- All other faults must be corrected by personnel in a HIAB service workshop!

Fault	Probable cause	Action
Electronic system will not start.	Parking brake on the truck is not engaged.	Engage parking brake on the truck.
The hydraulic pump makes a noise. <b>Warning! Stop using the crane immediately!</b>	Oil tank filler breather is clogged.	Clear the blockage or replace the entire filler cap.
	Oil level in the tank is too low.	Top up the oil tank and bleed the hydraulic system.
	Hydraulic pump is faulty.	Go to a HIAB service workshop.
Leak on hydraulic system: leaking coupling, hose or line. <b>Danger! Keep away from any oil leak.</b>		1. Push in the Stop button [If fitted].
		2. Disengage the PTO.
		3. Contact a HIAB service workshop.



Fault	Probable cause	Action
Stabiliser extensions do not slide out.	Stabiliser extensions are still locked.	Unlock the stabiliser extensions.
	Hydraulic fault.	Go to a HIAB service workshop.
The stabiliser extensions do not slide out/in. (Chain-driven stabiliser system)	Incorrect chain tension.	Contact a HIAB service workshop.
The stabiliser leg cylinder cannot keep the truck load and it goes inwards.	Check valve damaged.	Go to a HIAB service workshop.
	Cylinder internal leakage.	Go to a HIAB service workshop.
	Soft ground surface.	Set again the stabiliser led onto the ground or add an extra support plate between the cylinder and ground.
Slewing support cylinders do not turn	Three-way valve failure.	Go to a HIAB service workshop.
Irregular slewing movements and unusual noises in cranes with rack and pinion slewing system.	Insufficient oil in the hydraulic system.	Top up the oil tank.
	Insufficient oil in the slewing housing.	Top up the oil in the slewing housing to the required level.
	The upper slewing bearing is not properly lubricated.	Lubricate the bearing.
	The bearings in the slewing housing are damaged.	Go to a HIAB service workshop.
Irregular slewing movements and unusual noises in cranes with continuous slewing system.	Insufficient oil in the hydraulic system.	Top up the oil tank.
	Insufficient oil in the gear box.	Top up the oil in the gear box to the required level.
	Bearing assemblies and pinion are not properly lubricated.	Lubricate the bearing while slewing.
	Bearing assemblies or pinion are damaged.	Go to a HIAB service workshop.

Fault	Probable cause	Action
One function of the controller does not work.	One lever of the controller was not in neutral at start up.	1. Push in the Stop button.
		2. Make sure that all levers are in neutral.
		3. Release the Stop button.
Crane does not react to controls. Indicator lamps light up on the user panel.	The crane is in an OLP situation.	Perform movements to reduce the load moment. If necessary, release OLP.
Crane does not work properly: One or more crane functions do not work, or not properly. Lifting capacity is much less than normal. Operating speed is significantly reduced. The service lamp is lit.	The system has detected a fault.	Contact a HIAB service workshop.
Crane performance when operating it with the controller is unsatisfactory.	The pressure-reducer filter is clogged.	Replace the pressure-reducer filter.
Boom system cannot keep the load height, and it goes down by itself.	Load holding valves on the first boom or second boom damaged.	Go to a HIAB service workshop.
	Cylinder internal leakage.	Go to a HIAB service workshop.
Boom extension cylinders do not follow the sequence.	Cylinder internal leakage.	Go to a HIAB service workshop.
Boom extensions shake during extending/retracting function.	Cylinder internal leakage.	Go to a HIAB service workshop.
	Sequence screw in cylinder head loose.	Tight the screw in the right position.
Boom extensions cannot keep the load height and they move out by themselves.	Extension load holding valve damaged.	Go to a HIAB service workshop.
	Cylinder internal leakage.	Go to a HIAB service workshop.

Fault	Probable cause	Action
Add-on equipment does not work properly (rotator, hoist, etc.)	Connectors not properly connected.	Reconnect the add-on equipment, according to the instructions.
	Other defect.	Go to a HIAB service workshop.

### 8.6.3 Display [option]

The display has three menu items: *Error codes*, *Timers & Counters* and *VSL*. These items are shown on the screen when the display is first engaged. To be able to select an item push the menu toggle button or the OK button. In the bottom left of the screen the name of the item currently highlighted is shown.

#### Buttons

- ① Push to go back to main menu
- ② Push to go back one step
- ③ Push to toggle between menu items
- ④ Push to select item

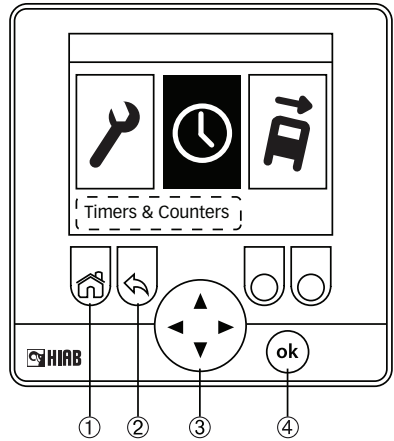

#### Menu items

##### *Error codes*

If item *Error codes* is selected and there are errors present in the system the screen will show a three digit number for each fault in the system.

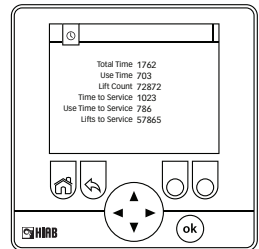

*Timers & Counters*

When item is selected information is shown about:

- Total time - Number of hours that the crane has been engaged
- Use time – Number of hours that dump valve has been active
- Lift count – Number of lifts made
- Time to service – Number of hours with the crane engaged until next service
- Use time to next service – Number of hours with dump valve active until next service
- Lifts to service – Number of lifts until next service

*VSL*

If this item is selected the truck VSL diagram is shown. The diagram shows six sectors surrounding the crane and in each sector a percentage is shown. A percentage of 90 indicates that the working pressure is reduced to 90% in this sector to guarantee full stability. The different sectors are marked in colors green, yellow, grey or red where green indicates the highest percentage of working pressure and red indicates the lowest percentage.

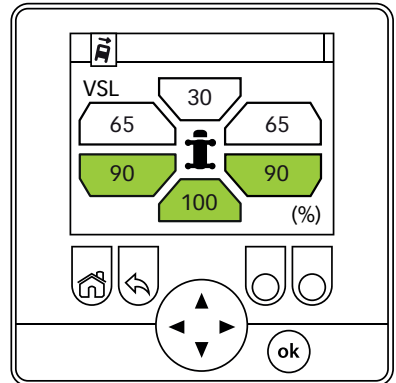
**Function indication**

If function LSS-V is activated the screen turns blue and a symbol of a hook is shown. This to notify the operator of the occurrence. When the screen goes back to normal the symbol of the hook is shown in the top right of the screen. When deactivating LSS-V the screen turns blue again and the hook symbol is shown, this time crossed in a red circle. The hook symbol in the top right of the screen disappears.

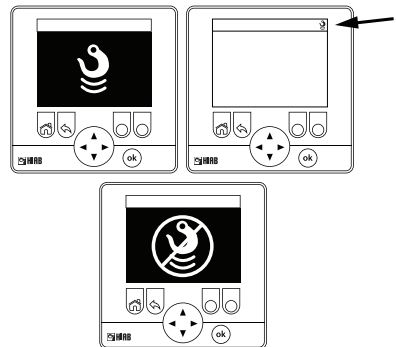

## 9.1 Decommissioning a crane

Cranes are designed and manufactured taking the environment into consideration. Environmental requirements and soundness have been considered when selecting the raw materials. The metal parts are designed to achieve a light and durable construction, this includes the selection of higher-quality grades of steel. When the crane is decommissioned at the end of its service life, years from now, waste will be created, which must be utilized and disposed of correctly. The crane must be decommissioned properly. Most of the crane's raw materials can be recycled.

### Follow the regulations of the local authorities!

- Oil and grease must not be spilled on to the ground or released into the environment!
- Drain the oil from hydraulic cylinders, valves and hoses.

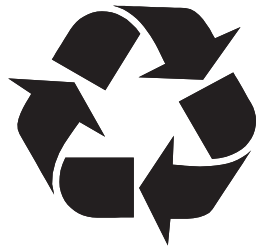

### Sort the waste

- Deliver the metal parts for recycling, for reuse as raw material. These are load-bearing, structures manufactured from steel or cast iron, hydraulic cylinders and lines drained of oil, directional control valves, shafts, bearing bushes, control levers, small parts.

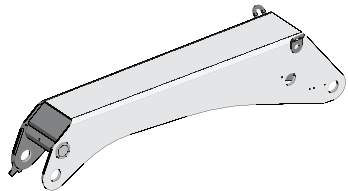

**Energy waste** can be utilized by incinerating it at a proper waste incineration plant

- spiral wraps, manufactured from polyethylene, plastic, bearings (cleaned of lubricants) used in the column, beam system etc, manufactured from polyamide plastic.

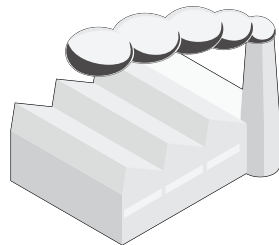

**Unsorted waste** should be delivered to a landfill

- drained hydraulic hoses, electrical wires, control cables, seat, hydraulic cylinder seals, lights, small plastic and rubber parts.



**Hazardous waste** is delivered to a collection point for hazardous waste

- oils: hydraulic oil, transmission oil from the slewing system
- solid lubricants: greases from the joints and journal bearings
- other waste containing oils and greases: hydraulic oil filters.



### European Union—Disposal Information

This symbol identifies the parts of your crane that need to be disposed of separately from household waste according to EU legislation. When one of these parts reaches the end of its life, take it to a collection site designated by local authorities. Responsible collection and recycling helps protect natural resources, environment and human health.



### 10.1 Documentation

The Technical Data document shows diagrams and technical information about your specific crane

**The enclosed Technical Data printed out by the installer should be stored together with this Operator's manual.**

### 10.2 Identification of the loader crane

The information below is to be filled in by the installer. The same information will be found on the serial number plate on the crane:

Mark: HIAB

Type: .....

Serial number: .....

Manufact. year: .....

### 10.3 Abbreviations

- ADC - ('Automatic Duty Control') - Automatic Duty Control
- ADO - ('Automatic Dumping of Oil') - Automatic Dumping of Oil
- APO - ('Automatic Power Off') - Automatic Power Off
- ASC - ('Automatic Speed Control') - Automatic Speed Control
- BDA - ('Boom Deployment Assistant') - Boom Deployment Assistant
- CTC - ('Crane Tip Control') - Crane Tip Control
- DA modules - ('Digital Amplifier Modules') - Digital Amplifier Modules
- HDC - ('Hoist Dual Capacity') - Hoist Dual Capacity
- JDC - ('Jib Dual Capacity') - Jib Dual Capacity
- LSS-H - ('Load Stabilising System-Horizontal') - Load Stabilising System-Horizontal
- LSS-V - ('Load Stabilising System-Vertical') - Load Stabilising System-Vertical
- MEWP - ('Mobile Elevating Work Platform') - Mobile Elevating Work Platform
- MSC - ('Manual Speed Control') - Manual Speed Control
- MUX - ('Multiplexer Box') - Multiplexer Box
- OLP - ('Overload Protection') - Overload Protection
- OPS - ('Operator Protection System') - Operator Protection System
- PFD - ('Pump Flow Distribution') - Pump Flow Distribution
- PSB - ('Power Supply Box') - Power Supply Box
- SAF - ('Semi Automatic Folding') - Semi Automatic Folding
- SCB - ('Stabiliser Control Box') - Stabiliser Control Box
- SSL - ('Sector Stability Limit') - Sector Stability Limit
- TWI - ('Transport Warning Interface') - Transport Warning Interface
- UI - ('User Interface') - User Interface
- VSL - ('Variable Stability Logic') - Variable Stability Logic
- VSL+ - ('Variable Stability Logic Plus') - Variable Stability Logic Plus



**10.4 Daily inspection checklist to photocopy**

<b>Operator:</b>		<b>Document ID:</b>	
<b>Crane s/n:</b>		<b>Date:</b>	

	OK	No OK*	N/A	Comments
<b>1. VISUAL INSPECTION</b>				
1.1 Presence of signs and symbols				
1.2 Locking devices				
1.3 Shafts, shaft lockings, bearings and bushings				
1.4 Crane structure				
1.5 Hooks				
1.6 Add-on equipment and separate lifting accessories				
1.7 Electronic components				
1.8 Security seal wires				
1.9 Oil level in the slewing housing				
1.10 Oil level in the slewing motors				
1.11 Oil level in the tank				
1.12 Filters				
<b>2. FUNCTIONAL TESTS</b>				
2.1 Stop buttons				
2.2 Levers				
2.3 Controller				
2.4 LED test				
2.5 Hydraulic system				

\* If you find a fault that prevents you to operate the crane safely, contact to a Hiab authorized service workshop. Do not try to repair the fault, it can cause you injury or you can damage the equipment.

Permission to reproduce this checklist is granted; however please note that only the original document owned by Hiab will contain necessary amendments and updates.

Hiab shall not be held liable if the copy in your possession does not contain the latest changes.

---

This page is intentionally blank.